

Allplan 2016

New Features in Allplan 2016-0

This documentation has been produced with the utmost care.

Allplan GmbH and the program authors have no liability to the purchaser or any other entity, with respect to any liability, loss, or damage caused, directly or indirectly by this software, including but not limited to, any interruptions of service, loss of business, anticipatory profits, or consequential damages resulting from the use or operation of this software. In the event of discrepancies between the descriptions and the program, the menu and program lines displayed by the program take precedence.

Information in this documentation is subject to change without notice. Companies, names and data used in examples are fictitious unless otherwise noted. No part of this documentation may be reproduced or transmitted in any form or by means, electronic or mechanical, for any purpose, without the express written permission of Allplan GmbH.

Allfa® is a registered trademark of Allplan GmbH, Munich.
Allplan® is a registered trademark of Nemetschek Group, Munich.
Adobe® and Acrobat PDF Library™ are trademarks or registered trademarks of Adobe Systems Incorporated.
AutoCAD®, DXF™ and 3D Studio MAX® are trademarks or registered trademarks of Autodesk Inc., San Rafael, CA.
BAMTEC® is a registered trademark of Häußler, Kempten, Germany.
Microsoft® and Windows® are either trademarks or registered trademarks of Microsoft Corporation.
MicroStation® is a registered trademark of Bentley Systems, Inc.
Parts of this product were developed using LEADTOOLS, (c) LEAD Technologies, Inc. All rights reserved.
Parts of this product were developed using the Xerces library of 'The Apache Software Foundation'.
fyiReporting Software LLC developed parts of this product using the fyiReporting library, which is released for use with the Apache Software license, version 2.
Allplan update packages are created using 7-Zip, (c) Igor Pavlov.
CineRender, Render-Engine and parts of documentation; copyright 2014 MAXON Computer GmbH. All rights reserved.
All other (registered) trademarks are the property of their respective owners.

© Allplan GmbH, Munich. All rights reserved.

1st edition, July 2015

Document no. 160eng01m01-1-TD0715

Contents

Welcome	1
New Licensing System.....	3
Activating a license in online mode.....	4
Returning a license in online mode	5
Updating licenses in online mode.....	5
License settings dialog box.....	6
FAQs.....	9
License server	10
General New Features	11
Multi-display support (floating viewports)	11
Floating viewports freely.....	12
Placing viewports in front of or behind the Allplan application window	12
Docking viewports to the Allplan application window	13
Objects palette - object navigator	14
Entries in feet and inches.....	21
Rules for entering American units.....	23
Improved help index	25
Interfaces.....	27
Adjusting coordinates during DXF/DWG import.....	27
DGN interface	28
IFC interface	29

Importing LandXML data.....	30
Transferring data to SCIA.....	30
Layouts and Printing	31
Resizing factor for multiple output.....	31
Transferring layer visibility.....	32
Rotating print preview	32
3D Modeling	33
New modeling kernel.....	34
Improved 3D elements	34
Round 3D elements	35
New modeling tools	38
Extrude along path.....	38
Rotate	39
Loft.....	40
Sweep path	42
Extrude as a new element.....	43
Extruding outlines on a surface.....	43
Modification tools in 3D.....	44
Modifications using handles and the properties palette	44
New tools for modifying solids.....	46
Modifications both in 2D and in 3D.....	48
More options for element filter	49
More options for converting elements	50
Improved data exchange	51
Interface to Rhine.....	51
Interface to CINEMA 4D.....	51
Interface to AutoCAD	51

Presentation and Animation.....	53
View types	53
White model.....	53
Optimized sketch view type.....	54
More information on real-time rendering.....	55
Simplified model when switching views.....	56
Animation.....	57
Copying light sources	57
Controlling illuminance	58
Rendering	59
Rendering using CineRender R15	59
New shading technique: ambient occlusion.....	59
SmartParts.....	63
Preview icons for your own SmartParts	64
Skylight SmartPart.....	65
New fittings for window SmartParts and door SmartParts	67
New door SmartPart	68
Surface elements in 2D and 3D.....	69
More new features in the Architecture family.....	72
Door swing as an architectural element.....	72
Libraries	73
General new features for libraries.....	74
Flat hierarchy	74
Single files instead of catalog folders	75
Managing library elements	75
Symbols and smart symbols with resources	77

Libraries provided.....	77
New library elements.....	78
Revised library elements.....	79
Definition and resources of smart symbols.....	79
Data conversion of your own libraries when upgrading.....	81
Libraries in the office standard.....	82
Libraries in the project and private paths.....	83
External path.....	84
Libraries from Allplan 2015.....	85
Section Along Curve.....	87
What to display and how.....	88
Dimensions.....	90
Engineering.....	91
Modifications using handles.....	92
Exporting bar reinforcement.....	93
Symbol selection.....	93
Additional steel grades for Australia.....	94
Associative Views.....	95
Unwanted linking of drawing files.....	96
Modifying text parameters.....	97
Section display.....	98
Index.....	99

Welcome

Dear Sir or Madam,

As one of the leading providers in the AEC industry and as the innovator in Building Information Modeling (BIM), Allplan offers modern technology, allowing all those involved in BIM projects to cooperate seamlessly. The BIM solution Allplan with its component-oriented 3D model is the ideal basis: the open platform supports comprehensive and optimized design, construction and management of buildings and real estate, making life easier for all project partners. By increasing planning efficiency, Allplan helps reduce costs right from the outset.

Development of Allplan 2016 focused on model creation. Allplan 2016 opens up completely new options in 3D modeling and simplifies the creation of structured BIM models, making your workflows even more efficient and intuitive.

We wish you every success!

Allplan GmbH

New Licensing System

Allplan 2016 uses a new licensing system for software protection. You require a Product Key for installing and activating Allplan.

The Product Key is a unique, 26-digit character string. You can use it to activate a license for Allplan. You can find your Product Key in Allplan Connect. Go to <https://connect.allplan.com/licence>. If you are a new customer or a beta tester, you will receive an additional email with the Product Key.

When you use a Product Key to license Allplan, you connect the license with the computer where you activate it. Before you can use the license on a different computer, you first have to return the license (see "Returning a license in online mode" on page 5) on the computer where you activated it. Then you can activate (see "Activating a license in online mode" on page 4) it on a different computer.

You can activate and return licenses both offline and online. However, if you activated a license offline, you also have to return it offline. It is much easier to activate a license online than offline. The computer where you want to activate the license does not have to be online all the time. It is enough if it is online during the actual activation process. Running Allplan does not require Internet access.

Activating a license in online mode

You can activate a license while you are installing Allplan or after you have installed Allplan. By activating a license, you connect the license with the computer. As a result, you can start Allplan on this computer.

Note: The easiest way to activate and return Allplan licenses is to do this online. In other words, the computer has Internet access. However, you can also activate Allplan on a computer without Internet access. For more information, see <http://allplan-online-help.nemallplan.net/Allplan/2016-0/1031/Allplan/index.htm#84747.htm>.

You can activate a license in online mode only if you have ...

- Internet access
- a Product Key

To activate a license during installation

- 1 In the **Installation Option** dialog box, select the **Enter Product Key** option and click **Next**.
- 2 Enter your **Product Key**.
- 3 Click **Activate license**.

To activate a license after you have installed Allplan

- 1 Open the **License settings** dialog box (Services application - Utilities - License settings).
 - 2 Click **License activation** on the left.
 - 3 Enter your **Product Key**.
 - 4 Click **Activate license**.
-

Returning a license in online mode

If you activated the license by entering a Product Key, you can return the Product Key and then use it on a different computer.

Note: The easiest way to activate and return Allplan licenses is to do this online. In other words, the computer has Internet access. However, you can also activate Allplan on a computer without Internet access. For more information, see <http://allplan-online-help.nemallplan.net/Allplan/2016-0/1031/Allplan/index.htm#84747.htm>.

To return a license in online mode

- 1 Open the **License settings** dialog box (Services application - Utilities - License settings).
- 2 Click **License activation** on the left. Then click the license you want to return.
- 3 Click **Return license**.

You can now activate the license on a different computer.

Updating licenses in online mode

You have to update the license when you have purchased an additional option or additional licenses for a license server license.

To update a license

- 1 Open the **License settings** dialog box (Services application - Utilities - License settings).
 - 2 Click **License activation** on the left. Then click the license you want to update.
 - 3 Click **Update license**.
-

License settings dialog box

In the License settings dialog box, you can specify the license you want to use to start Allplan. In addition, you can activate and return licenses. To open this dialog box, start the Services application and click Utilities - License settings.

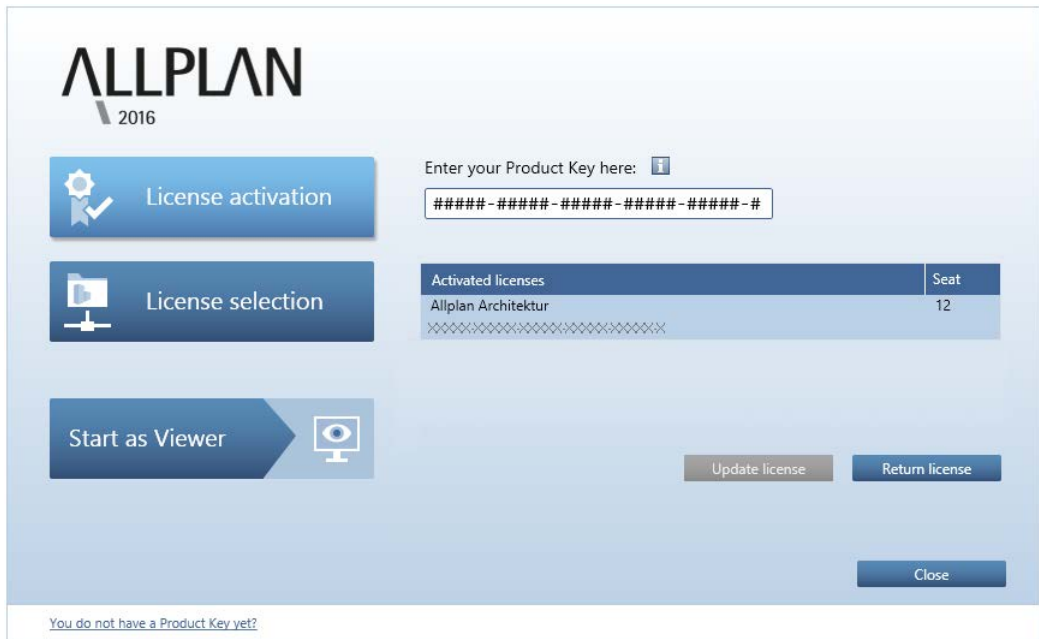

The dialog box is divided into three sections:

- **License activation:** use this section if you want to activate the license by entering a Product Key or if you want to return or update a license.
- **License selection:** use this section if you get the license from a license server or if you have several licenses and you want to select the preferred license.
- **Start as Viewer:** click this button if you want to start Allplan as a viewer.

Enter your Product Key here.

This is where you enter the Product Key for Allplan. The easiest way to enter the Product Key is to copy it to the Clipboard. Then you can paste it into the box using CTRL+V or the shortcut menu. After you have done this, Allplan checks whether the Product Key is valid. If the Product Key is valid and the license has not been activated yet, you will see the **Activate license** button. Click it to activate your license.

Activate license

After you have entered a valid Product Key, you can activate your license by clicking **Activate license**. This connects the license with the computer where you activated it. As a result, you can see the **Activation has been completed successfully** message.

Activated licenses

This area shows all licenses that are active on this computer.

Updating the license

This button is only active when you can update your license. For example, you have purchased a new module or additional licenses for a license server. Go to the **Activated licenses** area, select the license you want to update. Then click **Update license**.

Returning the license

If a license is active, you can return this license to use it for a different computer, for example. Go to the **Activated licenses** area, select the license you want to return. Then click **Return license**.

Available licenses

You can see the names of the available licenses here.



Seat no.

You can see the seat number here.

Available

This column shows how many licenses are still available. For licenses provided by a license server, you can click a dropdown arrow to see the users who are working with a license.

Priority

Click  to select one or more licenses as favorites. Allplan will then prefer these licenses. Click  to select one or more licenses Allplan is not to use. If you do not select any license or if you have selected several favorites, Allplan will automatically use the first free license it finds.

Find license server automatically

When you select this option, Allplan detects a license server on the LAN automatically. In some cases, such as VPN connections, Allplan may not be able to detect a server automatically. In this case, you can enter the server manually (see **Additional server name**).

Note: Only the Windows administrator can change this option.

Additional server name

If **Find automatically** is not active or Allplan has not automatically found a license server, you can manually enter the name or the IP address of the server. If **Find automatically** is active, you can enter an additional server. After having entered the server name, click **Update** to see the licenses of the license server. Use semicolons to separate several server names.



Update

This is where you can update the list of license servers, for example, after you have entered an additional server name.

You can configure Allplan to start as a viewer. Click **Start as a viewer**.

FAQs

What are the advantages of the new licensing method?

Better protection; easier to use (for example, when you want to transfer the license to a different computer).

What is the Product Key?

The Product Key is a unique, 26-digit character string. You can use it to activate a license for Allplan.

How do I get my Product Key(s)?

If you are the administrator of your company, you can find your Product Key at <https://connect.allplan.com/licence>. If you are a new customer, you will receive an additional email with your Product Key.

How do I transfer my activated license to a different computer or to a new computer?

Before you can transfer the license to a different computer, you first have to return the license on the computer where you originally activated it. Then you can enter the Product Key on a different computer, activating the license there.

How do I install Allplan or activate my license on a computer without Internet access?

The easiest way to activate and return Allplan licenses is to do this online. In other words, the computer has Internet access. However, you can also activate Allplan on a computer without Internet access. For more information, see <http://allplan-online-help.nemallplan.net/Allplan/2016-0/1031/Allplan/index.htm#84747.htm>.

How can I update a license (for example, after I have purchased an additional option)?

Open the License settings dialog box. Go to the License activation area and click the license you want to update. Then click **Update license**.

Can I still use hardlocks?

No, you can't. Allplan 2016 no longer supports hardlocks.

How do I install Allplan as a trial version?

Download Allplan 2016 from Allplan Connect. You will receive the Product Key for the trial version by email.

License server

The license server is part of the CodeMeter driver, which is installed along with Allplan. If you have already installed and activated Allplan on the server you want to use as the license server, you do not have to install additional software. But you can also install the license server separately; you do not have to install Allplan. In any case, install and activate the license server *before* you install Allplan on the clients.

To install the Allplan license server

Note: You can skip steps 1 to 3 if you have installed Allplan on the computer you want to use as the license server and activated the license server license there.

- 1 Download the software for the license server from Allplan Connect. Then start Setup on the computer you want to use as the license server.
- 2 Click **Install**.
- 3 Start the license server by starting the **License Manager** program. Go to the **License activation** area, enter your Product Key and click **Activate license**.
- 4 Start **CodeMeter Control Center** (Windows 7: on the Windows start menu, click **CodeMeter - CodeMeter Control Center**. Windows 8: on the Start screen, click the Search button to open Search. Enter **codemeter** and press ENTER). A dialog box opens. Click **WebAdmin** at bottom right.

Or:

Enter **localhost:22350** in the address bar of your browser.

- 5 Switch to the **Settings - Server** tab and select the **Start network server** option.
 - 6 Click **Apply**.
-

General New Features

Multi-display support (floating viewports)

You edit your model in viewports. Here, you create or modify the design entities you need. While doing so, you identify distinctive points and set the view type and view appropriate to the current status of your work.

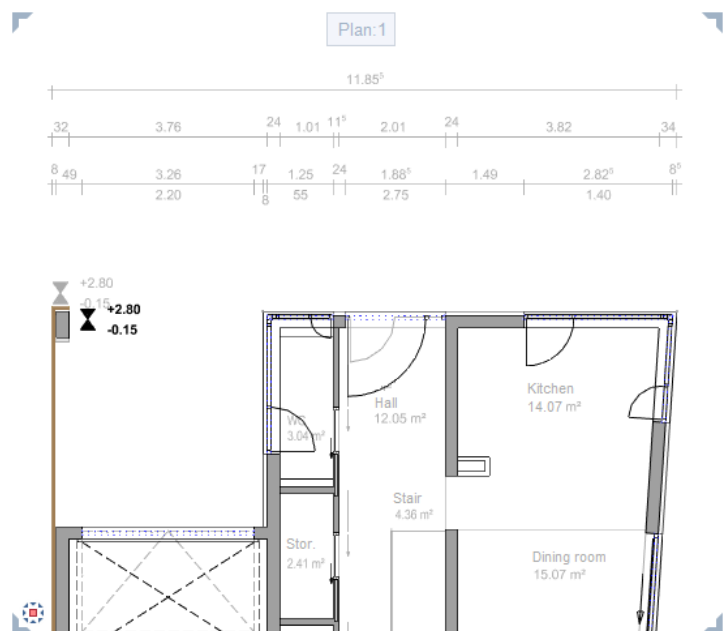

To maximize the workspace, you can now disconnect all viewports from the Allplan application window, thus floating them freely. As a result, the Allplan application window and the free-floating viewports behave as if they were independent Windows applications (except when you exit Allplan).

For example, if you have a second monitor, you can leave the Allplan application window on one monitor, using it as a "toolbox", while editing your model in the independent viewports you place on the second monitor.

Floating viewports freely

You can float viewports freely on screen, making them independent of the Allplan application window. You can use free-floating viewports as you would any other Windows application window.

Note: When you exit Allplan, the program closes *all* viewports, including the free-floating ones.

To float a viewport

- 1 Point to the title of the viewport you want to float.
- 2 Press and hold down the left mouse button.
- 3 Drag the viewport to its new position outside the Allplan application window. Then release the mouse button.

Note: It is the position of the cursor that is important. To float a viewport, you must position the cursor outside the working area.

Placing viewports in front of or behind the Allplan application window

You can place free-floating viewports in front of the Allplan application window without docking them.

Using ALT+TAB, you can then switch between the Allplan application window and the free-floating viewports as you would between independent Windows applications.

This option is particularly useful for workstations with a single monitor.

To place a viewport in front of or behind the Allplan application window

- 1 Press and hold down the CTRL KEY.
- 2 Drag the viewport to its new position in front of the Allplan application window.
- 3 Release the mouse button and then the CTRL KEY.
- 4 Press and hold down the ALT KEY.

- 5 Use the TAB KEY to select the viewport you want to bring to the front.
 - 6 Release the ALT KEY.
-

Docking viewports to the Allplan application window

The setting of the **Connecting** option (Window menu) controls how Allplan arranges the viewports in the working area:





- If this option is *active*, Allplan automatically defines the size and position of the viewport to be docked in accordance with the number and configuration of the other viewports that are currently open in the working area.
- If this option is *not active*, Allplan places the viewport to be docked exactly where the cursor and thus the title of the viewport is located when you release the mouse button. In doing so, Allplan does not change the size of the viewport.

To dock a free-floating viewport to the Allplan application window

- 1 Point to the title of the free-floating viewport.
 - 2 Press and hold down the left mouse button.
 - 3 Drag the viewport into the working area of the Allplan application window. Then release the mouse button.
-

Objects palette - object navigator

Allplan 2016 introduces a new palette - the **Objects palette**. The new **Objects palette** displays all components of a virtual building model in a clear and compact manner. You can control visibility, showing and hiding elements and element groups as you need. In addition, you can modify element information.

The **Objects palette** lists all objects and elements in the currently open drawing files (**current** or **open in edit mode** or **open in reference mode**). You can sort these objects and elements according to certain criteria. You can  show or  hide selected objects and elements as you need. You can even  activate or  deactivate objects and elements in the **Objects palette**. Using the  **Zoom** function, you can quickly zoom in on selected objects and elements or on groups of objects and elements. The elements are at the lowest level in each list. To zoom in on such a single element, double-click the element in the list with the left mouse button.

Using the various navigation options in the **Objects palette**, you can quickly and easily find the objects and elements you need.

The list box of the palette offers four icons with predefined sorting criteria:

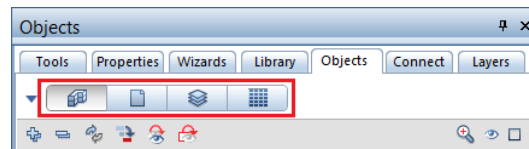

1  Sort by **building structure**:

This criterion combines all elements and objects in the currently open drawing files into groups and lists them alphabetically. You can find the objects and elements at the lowest level in each group. The top levels in the hierarchy are the details from the building structure.

Click  **Custom** to expand the list box of the Objects palette:

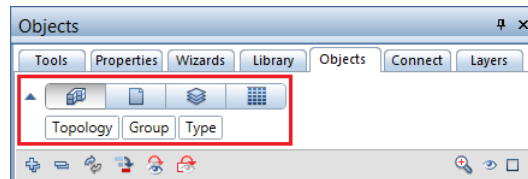

The categories displayed indicate the current sort sequence:

Topology - Element Group - Element Type.

When you move the cursor in the expanded list box, it changes to a double-headed arrow. By clicking a category and dragging it to a new position, you can change the sequence in which Allplan lists the objects and elements.





2 Sort by drawing file:

The drawing files containing the objects and elements are at the top level in the hierarchy. You can see all open drawing files, that is to say, the **current** drawing file and all drawing files that are open in **edit** and **reference** mode. Allplan takes these details from the building structure.

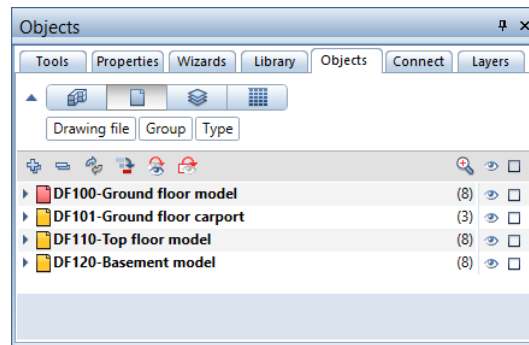
Here, too, you can click  **Custom** to switch between predefined and custom sorting.



When you point to the icon indicating the drawing file status in the list, Allplan opens a flyout where you can change the status of the drawing file. You can switch between  **Active**,  **In edit mode** and  **In reference mode**.



3 Sort by layer:





Here, the layers assigned to the objects and elements are at the top level in the hierarchy. If the elements of a group are assigned to different layers, they are listed under ***varied***.

Click  **Custom** to customize predefined sorting for your needs.

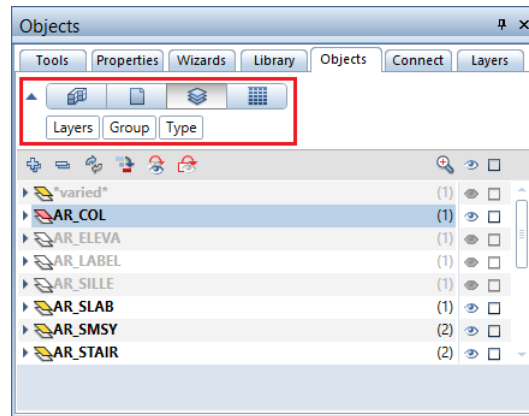
Here, you can change the sequence of the following categories:

Layer - Element Group - Element Type.



When you point to the icon indicating the layer status in the list, Allplan opens a flyout where you can change the status of the layer. You can switch between  **Current**,  **Modifiable**,  **Visible**, frozen and  **Hidden, frozen**.

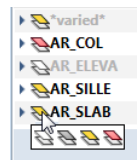

4 Sort by material:



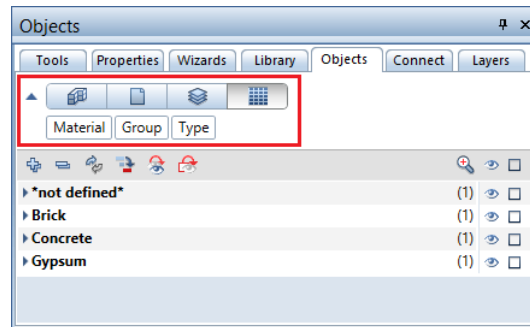

Here, the materials assigned to the objects and elements are at the top level in the hierarchy. Objects or elements without **Material** attributes can be found in the ***not defined*** list.

Click  **Custom** to customize predefined sorting for your needs. Here, you can change the sequence of the following categories: **Material - Element Group - Element Type**.

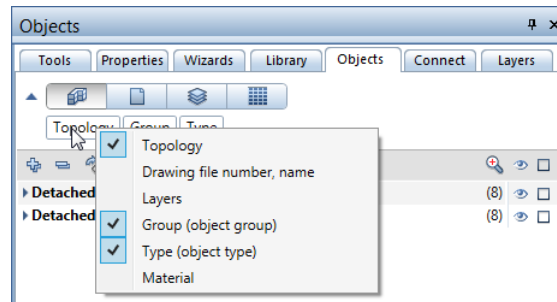



If you have customized sorting, the expanded list box offers a shortcut menu where you can add more categories or remove categories you do not need.



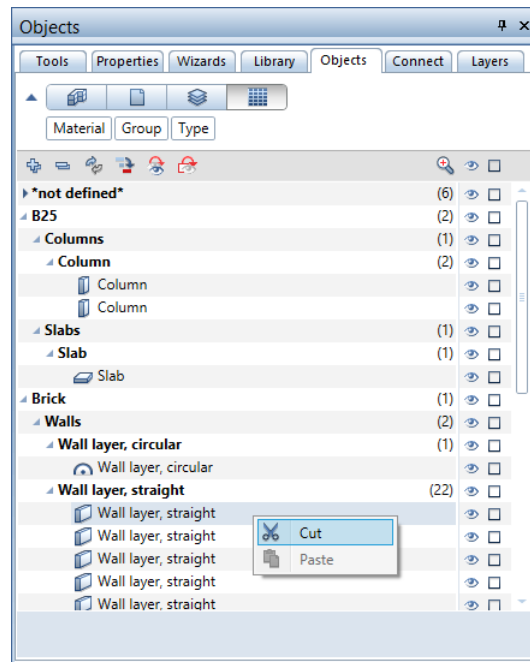

If you have selected the  Sort by layer or  Sort by material criterion, you can use drag-and-drop operations to assign a different layer or material to the elements listed. Requirements: the other layer or material is also listed and the element in question is visible () and on a layer you can modify (layer status set to  Current or  Modifiable).

To do this quickly, you can also use the shortcut menu (using the  Sort by Material criterion as an example):

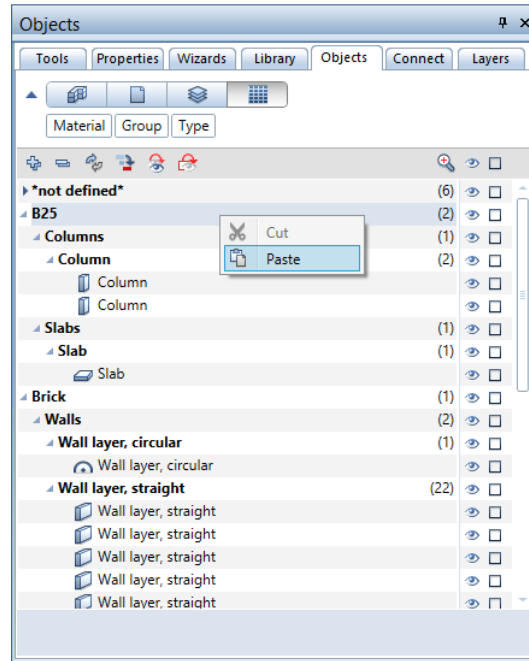

Click  **Cut** to cut an object or element or several objects or elements (at the lowest level in the hierarchy).
To assign a different material to the objects or elements cut, use the shortcut menu of the new material you want to assign:



Click  **Paste** to insert the object(s) or element(s) cut under the selected material. Allplan adds the object or element to the appropriate element **group**. If it cannot find an appropriate **group**, it creates a new one.

You can also find these shortcut menus when you  **Sort by layer**.

Entries in feet and inches

We improved the entry options for feet and inches, making it much easier for you to enter lengths in feet and inches in almost all modules. All definitions also apply to metric units. If units differ from the global setting, such as the units for entering the symbol size or text height, Allplan displays these units in the corresponding data entry boxes.

To set the unit of length, use the status bar or open the  **Options** on the **Desktop environment** page. You can choose between **Inches**, **Feet and inches** and **Feet**.

When you select **Feet**, the values you enter are always displayed as rounded decimals. When you select **Inches** or **Feet and inches**, however, you can specify how the decimal places of the values you enter are displayed. You can find detailed information on these formats in the help for Allplan.

When you have set the format of fraction to **Fraction** or **Fraction or decimal**, you can define the **Precision** by selecting the fraction Allplan is to use to display the values after it has rounded them off. Allplan may also reduce the fraction.

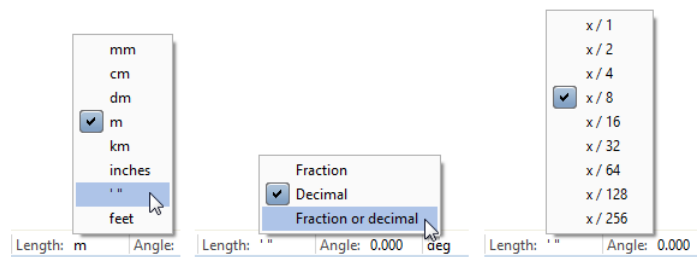

In addition, the  **Options** offer the **Use dot in decimals** as a **control character** option if you have set the unit of length to **Inches** or **Feet and inches** and the format of fraction to **Fraction**. Entering a dot is a common, simplified way to enter fractions in inches or to enter integers in feet and inches.

Selecting this option has the following effects:

- For length entries in **inches**, Allplan will interpret the dot as a fraction line.
1.2 will result in 1/2"
- For length entries in **feet and inches**, Allplan will interpret the dot as a separator.
1.2 will result in 1' 2"

When this option is not active or you add the unit ["] or ['] to a decimal, Allplan will interpret the dot as a decimal separator.

1.2 or 1.2" will result in 1 1/4"

1.2' will result in 14 1/2" or 1' 2 1/2"

Note: Regardless of whether you have selected this option or not, you can always use this type of entry with more than one dot.

For length entries in **inches**, 1.2.3 will result in 1 2/3"

For length entries in **feet and inches**, 1.2.3.4 will result in 1' 2 3/4"

For length entries in **feet**, 1.2.3.4 will result in 1' 2 3/4" = 1.229'

Rules for entering American units

Note: To get the same results as in these examples, set the length to **Feet and inches**, the format to **Fraction or decimal** and the precision to **x/8**.

1. Unit

- You can enter values with or without units.
- You can add the unit to the value with or without a space in between.
- You can combine different units.
- If you do not add a unit, the program uses the current unit.
- If you do not add a unit, the program interprets values you enter in **Feet and inches** as inches.

Enter	Internal value in [mm]	Result
2.54 cm	25.4	1"
69"	1752.6	5' 9"
1.5	38.1	1 1/2"

2. How to apply units

- The unit applies to all the values that are to the left of it as far as the next unit.

Enter	Values	Result
3 4' 2.54 cm 3 1/2"	3'+4'+1"+3"+1"/2"	7' 4 1/2"
3 4' 2 3 1/2	3'+4'+2"+3"+1"/2"	7' 5 1/2"
3 4 2 3 1/2	3"+4"+2"+3"+1"/2"	1' 1/2"

3. Operators

- You can use the following arithmetical operators: +, -, *, /, 0, (), ^, e (= power of ten for floating point representation)
- You can add an operator to a value with or without a space in between.
- The program uses the "+" operator if you do not specify an operator at the beginning.
- If there are no operators between successive values, the program will use the last "+" or "-" operator to the left.

Enter	Values	Result
$-4+2\ 1' - 12''+1$	$-4'+2'+1'-1'+1''$	$-1'\ 11''$
$14/2' - 6*10''\ 8\ 1/4$	$+7'-5'-8''-1''/4''$	$1'\ 3\ 3/4''$
$-1\ 2\ 3' (2^3)$	$-1'-2'-3'-(+2^+3)''$	$-6'\ 8''$

4. Miscellaneous

- You can use a point or a comma for the decimal separator.
- You can enter values in any sequence.

Enter	Values	Result
$5'0,5 - 1.125$	$5'+1''/2''-1''-1''/8''$	$4'\ 11\ 3/8''$
$-3''+6'\ 0,381dm$	$-3''+6'+1\ 1/2''$	$5'\ 10\ 1/2''$

Improved help index

We improved the contents, handling and display of the index in the help for Allplan:

- We edited the index entries by combining keywords, removing obsolete entries, deleting duplicate entries and adding meaningful keywords.
- We expanded the functionality of the index column. Now you can adjust its width to the size you need, thus avoiding confusing line breaks.

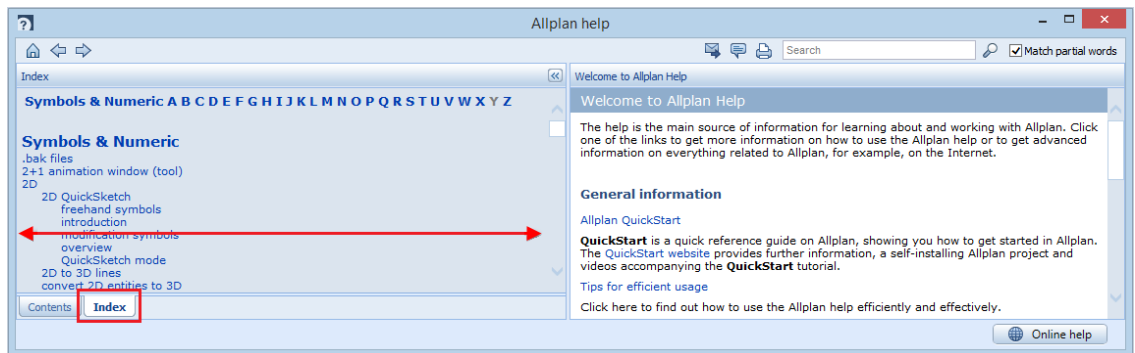

We are intensively working on further optimizations.

Interfaces

Adjusting coordinates during DXF/DWG import

Allplan checks the coordinates when importing DXF files and DWG files. If automatic assignment detects elements that are far from the Allplan global point, you can see the **Adjust coordinates** section in the configuration dialog box.

You have the following options to adjust the coordinates:

- **Move data to the origin (recommended)**
- **Calculate and enter the offset coordinates for the origin of the project**
(If there is a project offset, you cannot select this option.)
- **Do not adjust coordinates (not recommended)**

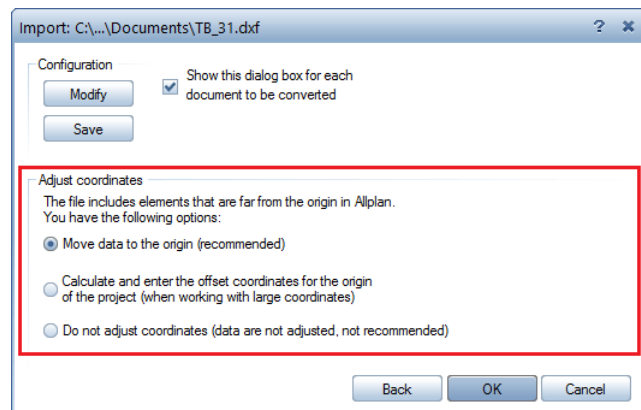

Expanded dialog box when importing data with large coordinates

The dialog box with the **Adjust coordinates** section appears even when you switched off the dialog box for import using drag-and-drop operations in the  **Options**.

Note: Allplan checks only the main document for large coordinates. References will be imported with the same setting as the main document.



Note: You cannot see this dialog box when you **import in batch mode** or when you have defined an **Additional offset** or selected the **Adjust center of gravity** option in the  **Settings**.

Note: In certain cases, automatic assignment does not detect large coordinates. It is possible that the references also contain elements that are far from the global point.

DGN interface

You can embed color tables from SEED files in DGN files. This feature is particularly useful when you work together with water and shipping authorities.

IFC interface

We added new options to the IFC Export, Import Settings. To open these settings, click  when you transfer data using  **Import IFC Data** or  **Export IFC Data**.

With the new **Structural Analysis View** export option, you transfer structural data of the following architectural elements: **wall, column, downstand beam, floor slab, upper slab** and **openings**. These elements are preset in the **Elements to be transferred** area. Structural programs can use these data as the basis for calculations. Any settings for **Additional offset** are not taken into account; the **Do not transfer hidden layers** option is not available.

You can select **Advanced XRefs** in the **Elements to be transferred** area, thus transferring elements embedded in **Advanced XRefs**. Allplan transfers the elements in accordance with the appropriate IFC ObjectType.

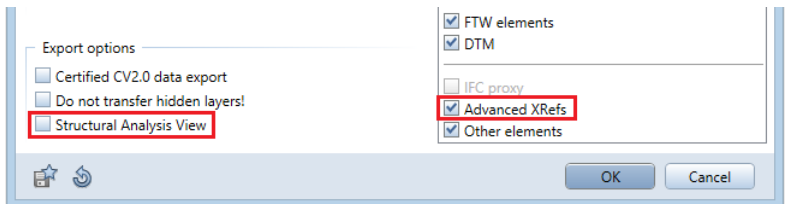



Importing LandXML data

The File menu - **Import** includes the new  **Import LandXML Data** tool.

You can use this tool to import LandXML data (versions 1 and 2) in *.xml format as composite elements to Allplan. These data can be 3D terrain points or route location lines. This tool allows you to import models you created in other programs. You can then continue to work on these models in Allplan. For example, you can use them as the basis for bridges or noise protection walls.

Allplan uses the original coordinates to place the data.

Transferring data to SCIA

As IFC import and IFC export are version-independent, these tools are ideally suited to exchanging data between Allplan and SCIA Engineer. Therefore, the  **Import Scia Engineer Data** and  **Import Scia Engineer Data** tools are no longer available in the Interfaces module.

Layouts and Printing

We mainly focused on completing the newly designed tools.

Resizing factor for multiple output

When printing multiple layouts, you can apply the **Resizing factor** and the **Resize pen thickness** option to all selected layouts with a single click.

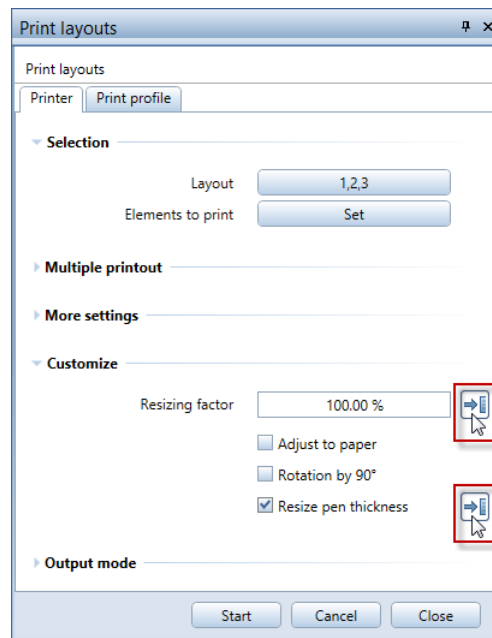

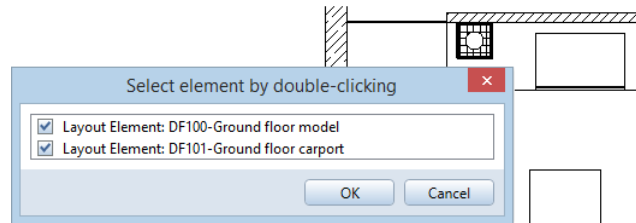

Transferring layer visibility

When transferring the layer visibility, you open a selection rectangle around the layout elements you want to select. In earlier versions, you used a dialog box to select the layout elements. If the  **Selection Option for Ambiguous Elements on/off** is active and there are several layout elements, you still select the layout elements in a dialog box as usual. By default, all layout elements are selected.



Rotating print preview

In response to repeated requests from our customers, we adjusted the newly designed print preview so that you can now rotate the section displayed.

After you have selected  **Print Preview**, click  **Rotate** (on the viewport toolbar) to rotate the section 90° counterclockwise click by click. This does not change the scale set.



3D Modeling

The modern architectural language is moving away from orthogonality. Sculptural structures are increasingly in demand. This trend means that planners need to be more and more flexible in designing. To achieve this, they require a software solution that allows them to model non-orthogonal structures precisely.

The world's leading Parasolid modeling kernel was integrated in **Allplan 2016**, giving planners a high degree of design freedom and maximum precision to create and modify 3D solids.

New modeling kernel

Allplan 2016 with its integrated Parasolid modeling kernel gives you exactly the degree of precision you need to create amorphous shapes. As a result, you can benefit from optimum performance, allowing you to model any shape you want.

The new 3D core makes it much easier for you to modify 3D solids. In addition, it considerably increases the display quality in the animation window. The high degree of precision in the 3D model also improves planning quality. Thus, Allplan 2016 stands for highest requirements on flexibility and precision in free forming.

Improved 3D elements

The new Parasolid modeling kernel offers you advanced options for creating real circles, arcs and curves. These new 3D elements are called **general 3D elements**, such as general 3D object, general 3D surface or general 3D curve.

Objects with curves and arcs include arcs and isocurves displayed as dashed lines, making it easy for you to identify them. If you are not sure about an object, just point to this object and check its selection preview:

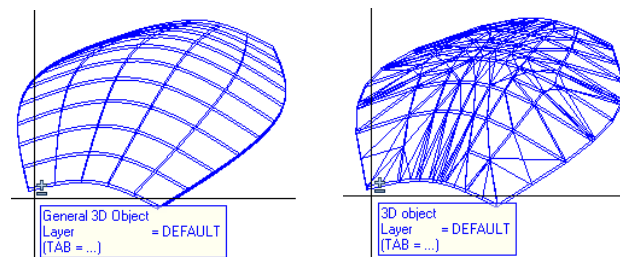



New general 3D object versus 3D object (polygonized)

Note: You have to convert these **general 3D elements** to polygonal elements before you can use them in other modules. To do this, you can find a new option in the  **Convert Elements** tool (see "More options for converting elements" on page 50).



Round 3D elements

3D elements you create as circles, circular surfaces, ellipses, ellipsoidal surfaces, splines, cylinders and spheres are round. Allplan no longer uses polygons to approximate these 3D elements.

3D circle

The  3D Line -  3D Circle tool lets you draw real circles as arcs. Allplan no longer uses polygons to approximate these 3D elements. Using handles and data entry boxes, you can modify the radius, start point, end point and opening angle of these elements. To modify several elements in a single step, you can use the properties palette.

3D spline

The  3D Line -  3D Spline tool lets you draw splines as cubic Hermite curves. Allplan no longer uses polylines to approximate these 3D elements. You can use handles to modify the defined control points. Using the properties palette, you can enter and modify the control points as coordinates.

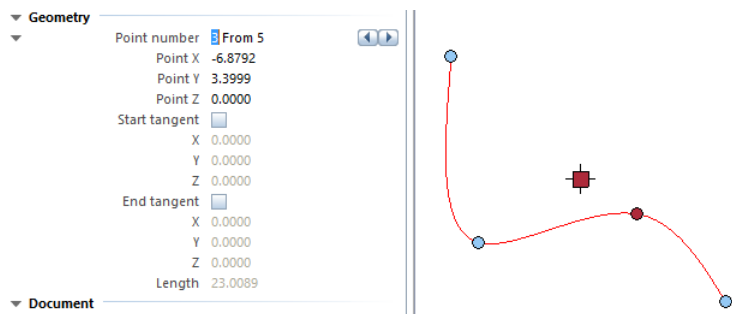

Cylinder

Cylinders you create using the  Cylinder tool are based on a real circle and delimited by curved surfaces. You no longer have to define the number of corners of the regular polygon.

Using handles, you can change the radius and height of a cylinder directly or by entering a value in a data entry box. The **Properties** palette provides further modification options.

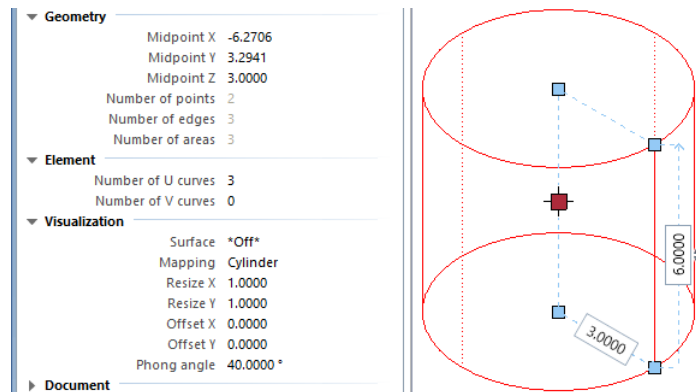

Sphere

Spheres you create using the  Sphere tool are delimited by curved surfaces. The distinction between triangular decomposition and globe has become irrelevant.

Using handles, you can change the radius of a sphere directly or by entering a value in a data entry box. The **Properties** palette provides further modification options.

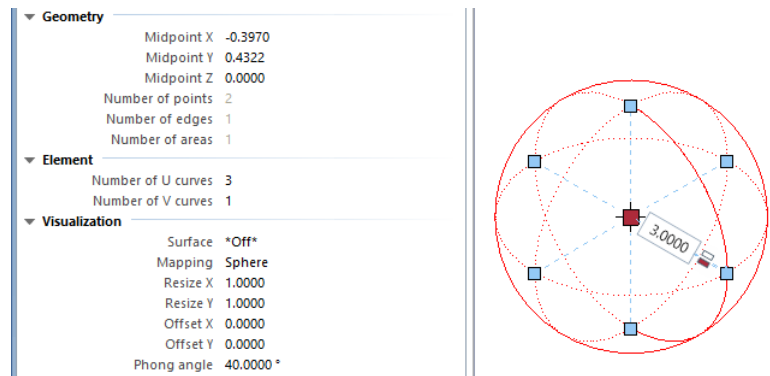

Spheres will be converted as globes to 3D objects.

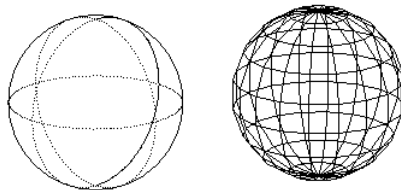

New modeling tools

The new modeling kernel opens up new dimensions of 3D modeling. Consequently, we added a number of new modeling tools, expanding or replacing the existing ones.

Note: You do not lose the basic elements (profile, path, axis and so on) when working with the new modeling tools. It is a good idea to draw the basic elements in a separate drawing file. You can then open this drawing file in edit mode and create the surfaces or solids in the current drawing file.

Extrude along path

The  **Extrude Along Path** tool replaces  **Polyline Sweep Solid**.

Using  **Extrude Along Path**, you create solids or surfaces by extruding an open or closed profile along a path.

Allplan displays a preview of the extruded element, presenting several options for turning the element along the path.

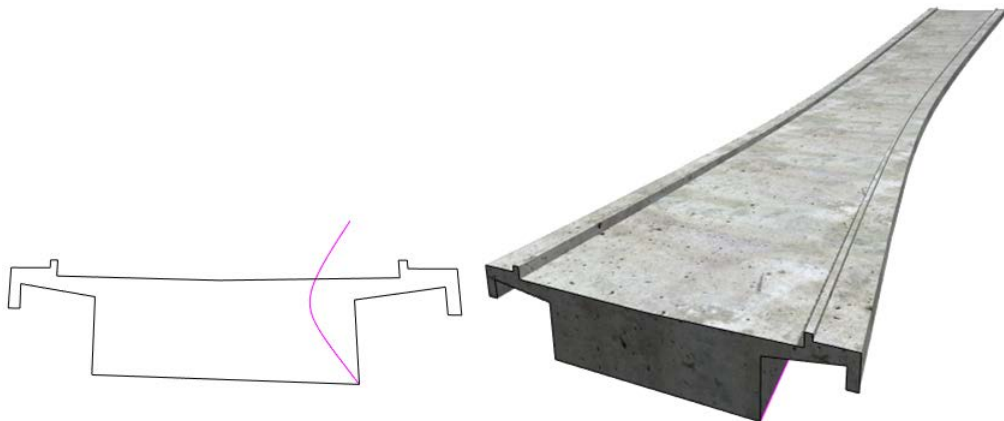

Note: The profile must be planar and continuous. It must not intersect. It can be open or closed. If the profile consists of several elements you cannot select with one click, you can use the  **Brackets**.

Note: The path must be planar and continuous. It must not intersect. You can even use a path that does not touch the profile. In this case, select the start point and the end point of the path and move it to the profile.

Rotate

The new  Rotate tool replaces  Solid of Revolution.

Using  Rotate, you create solids or surfaces by revolving a profile about an axis.

The profile may have gaps. You can even combine open and closed profiles. The axis of rotation does not have to be in the same plane as the profile.

Allplan displays a preview of the result. You can change the angle of rotation using handles or the data entry box until you click **Apply** to create the solid.

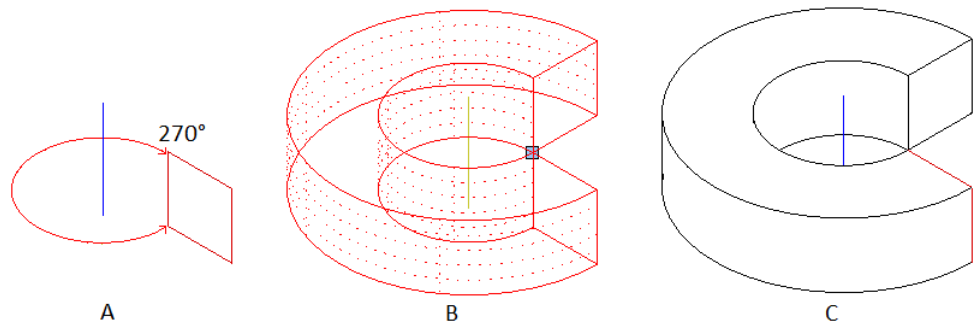

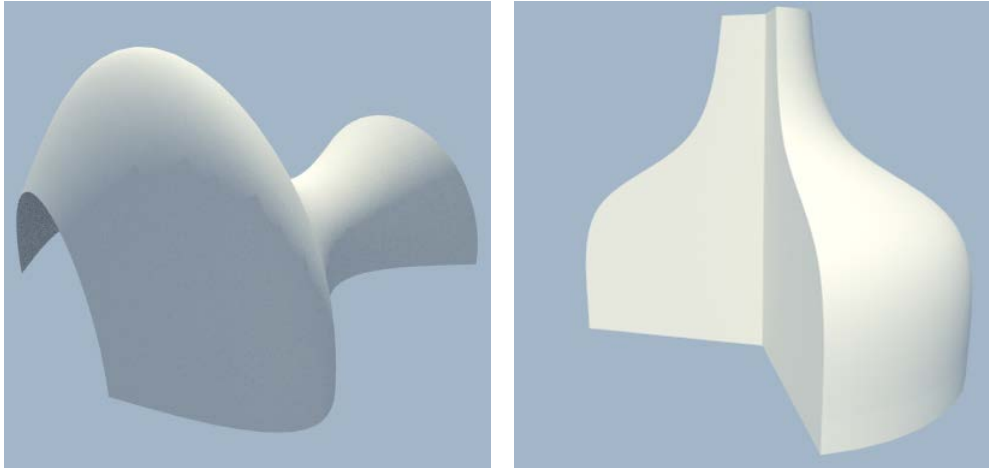

- (A) Profile and axis (isometric view)
- (B) Preview of solid (isometric view)
- (C) Final solid (hidden line image)

Note: If you use a closed profile or revolve the profile 360°, you can choose to create a solid or a surface. An open profile always produces a surface.



Loft

The new  Loft tool replaces  Ruled Solid.

Using  Loft, you join two or more open or closed planar profiles to form a single solid or surface. It is not necessary that the profiles have the same number of points or corners. Lines connecting the profiles are not required.

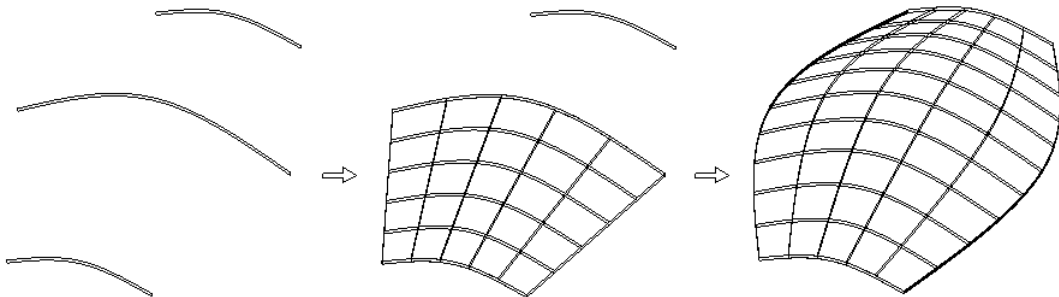



Note: If one of the profiles is not closed, you can create only surfaces. If you use a closed profile, you can choose to create an open solid or a closed solid.

Note: The profiles must be planar, but they do not have to be in parallel planes.

Note: Allplan connects the start points of the profiles. The other points follow in the sequence in which you entered them. This allows you to model twisted solids. If you want to avoid this, make sure the start points are more or less on top of one another and you enter the profiles in the same direction. You can even turn profiles later. If you cannot avoid turned or intersected solids,  Sweep Path (on page 41) may produce better results.



Sweep path



The  Sweep Path tool replaces  Tessellated Solid.

Using  Sweep Path, you create 3D solids or 3D surfaces from at least two profiles that are joined along at least one path. It is not necessary that the profiles are planar or have the same number of points or corners.

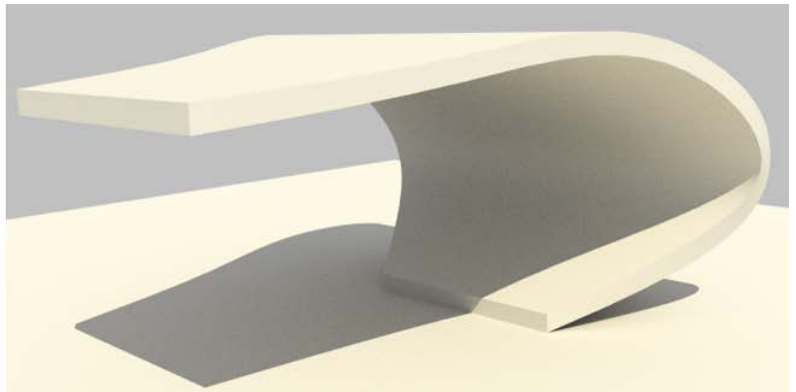
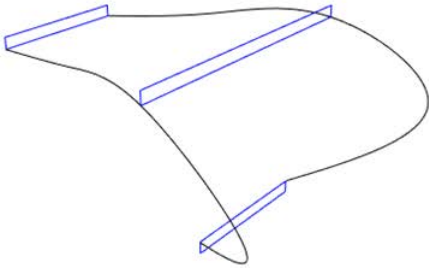
You can use as many profiles and paths as you want. The paths may even intersect; in this case, you must use at least two paths.



Extrude as a new element

We added the  **New element** option to the  **Extrude** tool. When you select this option, Allplan always creates a new element based on the element it extrudes. This does not change the existing element. In other words, Allplan neither adds nor subtracts the existing element. Using this new option, you can create similar surfaces or solids and move them to the position you need for further modifications using the new  **Extrude Along Path** tool, for example.



Extruding outlines on a surface

If you want to use  **Extrude** to extrude or cut out an outline on a surface, Allplan displays the X, Y and Z directions of the local coordinate system in the preview when you select the surface. These directions define the work plane.

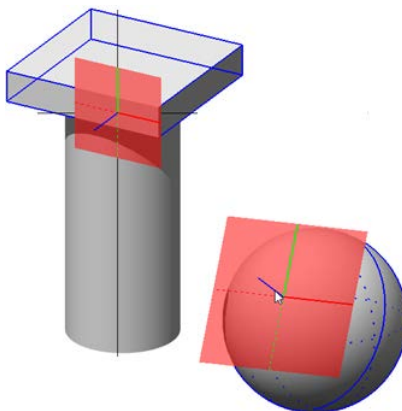

Modification tools in 3D

Modifications using handles and the properties palette

You can now use the options provided by **Direct Object Modification** to edit 3D elements as you would any other element or component: just select the element and use the handles and the data entry boxes to modify it. Some edit tools also provide handles for some settings, allowing you to intuitively adjust the radius of curves, for example.



3D elements in the properties palette

Using the **Properties** palette, you can now change the **Format properties** for one or more 3D elements. In addition, you can change the visualization settings, such as **Surface** and **Mapping**. For general 3D elements, you can control the type and number of isocurves (U-curves and V-curves).

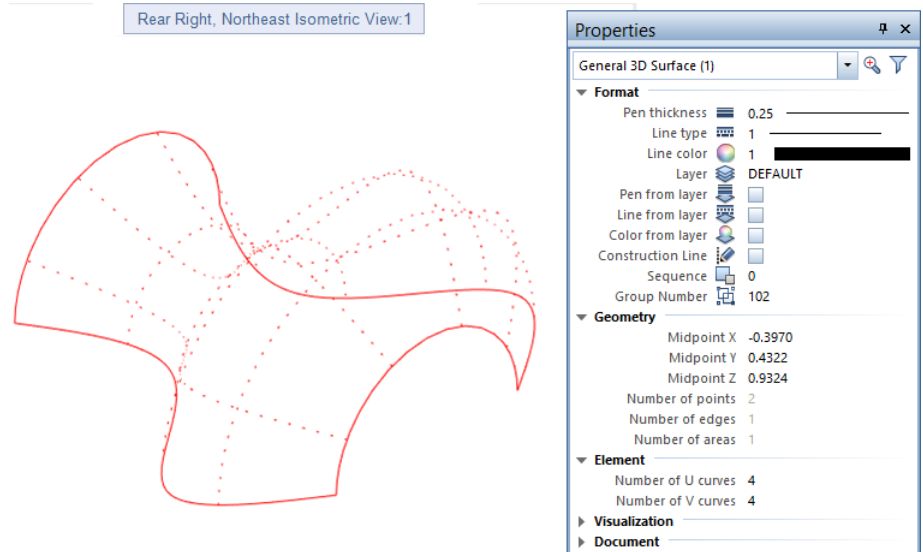

New tools for modifying solids

We developed new tools for modifying solids. These new tools are similar to those in the **Draft** module.

Modify edge offset

Using  **Modify edge offset**, you change two or more edges of a polygonal 3D solid or 3D surface by entering an offset. The edges must lie in the same plane.

Allplan displays a preview of the modified geometry until you place the point or confirm the value entered.

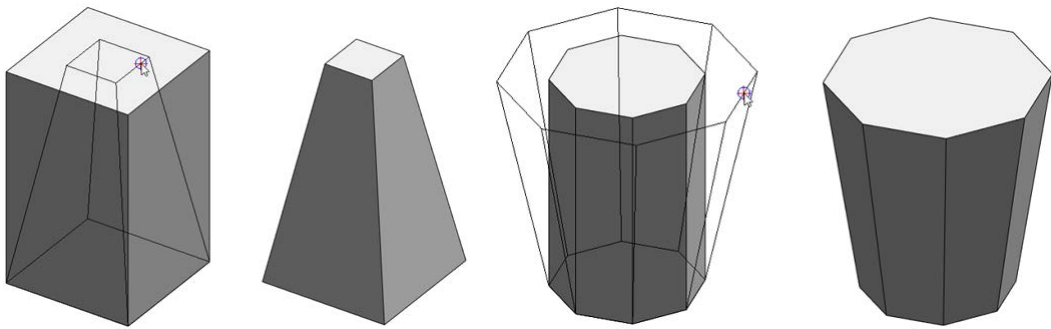

Fillet edge

Using  **Fillet Edge**, you fillet some or all edges of a 3D solid by entering a radius.

Allplan displays a preview of the entries until you click **Apply** to save the solid. **All edges** fillets all edges of the solid in a single step.

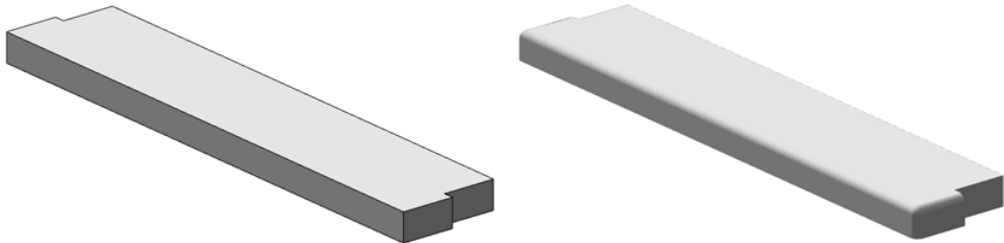

Chamfer edge

Using  **Chamfer Edge**, you chamfer some or all edges of a 3D solid by defining an offset. You can enter the offset as a value or using handles.

Allplan displays a preview of the entries until you click **Apply** to save the solid. All edges chamfers all edges of the solid in a single step.

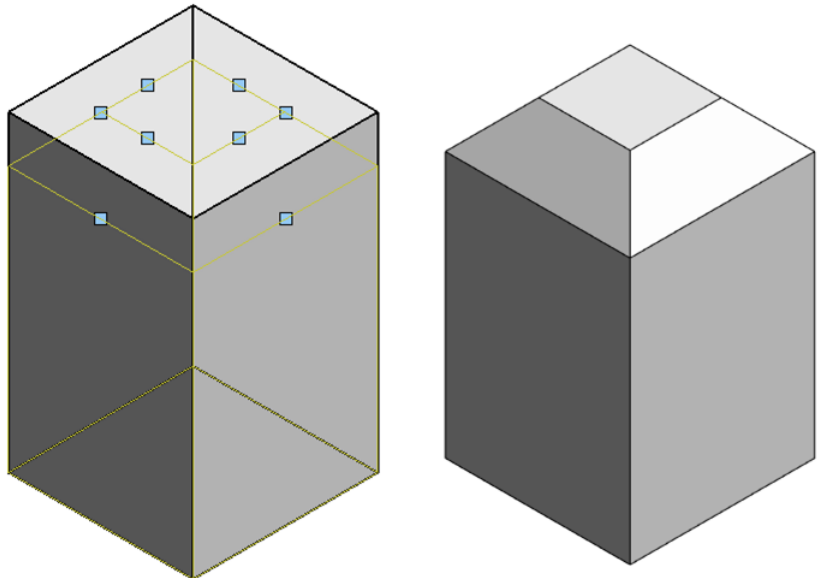



Modifications both in 2D and in 3D



A lot of modification tools you know from 2D are now available for 3D elements, too. Therefore, we added them to the 3D Modeling module.

You can apply the following tools to 3D lines in the same plane and 3D surfaces:



-  Intersect 2 Entities
-  Fillet
-  Chamfer

You can apply the following tools to 3D lines:

-  Combine Lines to Make Polylines
-  Split Polylines into Discrete Lines

Using the  3D Line and  3D Surface tools, you can now create drafts and sketches for complex 3D objects in three dimensions right from the start. You no longer have to rotate and convert them to 3D.

We added functionality to the following tools:

-  Slice
Using this tool, you can slice not only 3D solids but also 3D lines, 3D arcs and 3D splines.
-  Parallel Lines
You can now use this tool to create parallel 3D arcs and parallel 3D splines, too. Allplan displays a preview of parallel 3D elements in construction line color until you confirm the number of parallel elements by pressing the ENTER key.

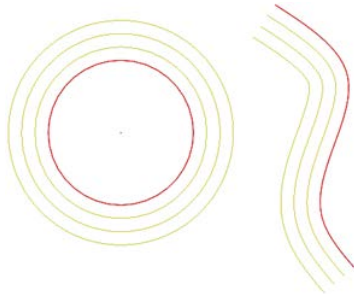

More options for element filter

We expanded the  Element Filter (Filter Assistant toolbar) so that you can edit the new 3D elements easily. Apart from the familiar 3D elements, you can now filter the new general 3D elements, 3D circles and 3D splines.

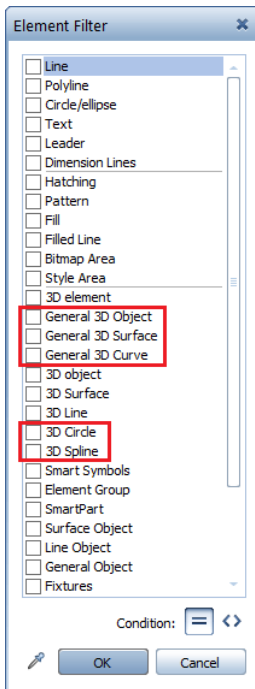

More options for converting elements

Before you can use general 3D elements, spheres or cylinders in other modules, such as the architectural modules, you have to convert the curves to polygonal elements.

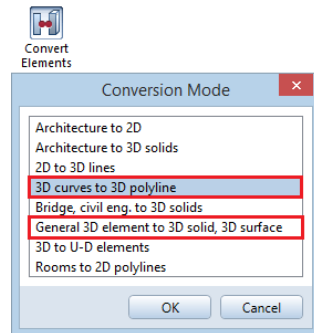

To do this, you can find new options in the  **Convert Elements** tool:

- **3D curves to 3D polyline**
- **General 3D element to 3D solid, 3D surface**

You can set the type and quality for conversion.

2D to 3D

Using the 2D to 3D lines option, you can now convert 2D arcs and 2D splines to 3D, too.



Improved data exchange

Interface to Rhine

Allplan exports circles, arcs and 3D splines as curves to Rhino.

Similarly, Allplan imports circles, arcs and 3D splines as curves from Rhino.

Interface to CINEMA 4D

Allplan exports circles, arcs and 3D splines as curves to CINEMA 4D.

Similarly, Allplan imports circles, arcs and 3D splines as curves from CINEMA 4D.

Interface to AutoCAD

Allplan imports circles, arcs and 3D splines as curves from AutoCAD.

Presentation and Animation

View types

We further developed the view types you can use to display your planning data on screen.

Tip: If you want to save a setting or scene as an image, use the **Save Contents of Viewport as a Bitmap** tool (File menu or shortcut menu in navigation mode).

White model

You can use the new **White model** option for view types using the **RT_Render** rendering method (for example, the predefined **RTRender** view type). This option displays your model in the style of an architectural model made of white paper or KAPA® panels.

Using this technique, Allplan automatically masks colored surfaces and textures, displaying the scene using light and dark shades and low contrast. Reflection and transparency are also taken into account.



To display your model as a "white model"

- 1 On the viewport toolbar, open the **View Type** list box.
- 2 Point to the view type you want to use to display your model as a white model.

Important!

You must select a view type that uses the **RT_Render** rendering method.

- 3 Click  **Edit view type**.

The **View type** palette opens.

- 4 In the **Settings** area, select the **White model** option.
 - 5 Click **Close**.
 - 6 Display your model using the view type you just edited.
-

Note: To return to the original settings, just deactivate the **White model** option again.

Optimized sketch view type

We optimized all view types that use the **Sketch** rendering method (for example, the predefined **Sketch** view type). As a result, Allplan no longer triangulates rough surfaces, that is to say, covers the surface with a net of triangles. Instead, Allplan now "rounds" the surfaces.

The resulting images are much more appealing.

More information on real-time rendering

You now get more information while Allplan is rendering an image in real time. All view types using the **RT_Render** rendering method (for example, the predefined **RTRender** view type) provide detailed information about the progress of the calculation.

Progress displayed as a percentage in conjunction with the "quality" stop criterion

When you selected the **Quality** stop criterion in earlier versions, Allplan did not inform you of the progress of the calculation. In other words, you did not know when Allplan reached the quality level set, thus completing the calculation.

You can now see the progress as a percentage:

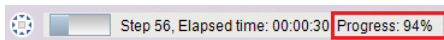

Info when rendering pauses

As soon as you interrupt a real-time rendering process (for example, by opening element selection), Allplan will indicate this:

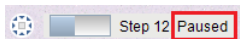

Simplified model when switching views

So that you can quickly switch between different views of complex and data-intensive models, view types using the **Hidden**, **Shaded** and **Sketch** rendering methods display only a simplified model as soon as they reach a certain amount of data. In doing so, Allplan temporarily hides the surfaces and textures of the model (illustration on the left). This allows you to change views quickly and smoothly.

Only after you have set the final view and released the mouse button will Allplan display the model with all its details (illustration on the right).



Animation

In animation, we expanded the options provided for illuminating scenes.

Copying light sources

Artificial light sources you defined for a project using  **Set Project Light** can be copied within the project. You can copy individual light sources or you can select several light sources and copy them together. To select several light sources, you can use the brackets or open a selection rectangle.

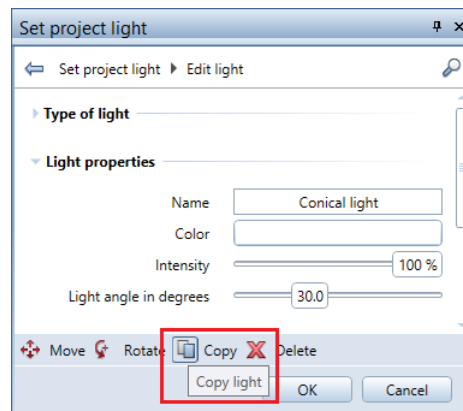

You can find more information on copying light sources in the help for Allplan.

Controlling illuminance

You can control the intensity of the light and thus the illuminance of artificial light sources you defined using  **Set Project Light**. By brightening or darkening individual light sources, you can simulate realistic lighting effects, making your scene even more appealing.

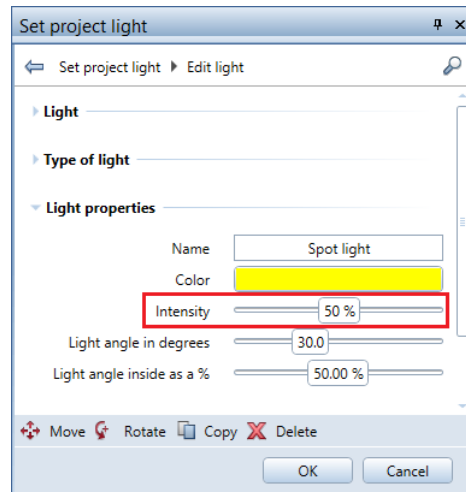

You can find more information in the help for Allplan. See the section "Setting a new light source".

Rendering

Rendering also opens up new options for simulating realistic lighting conditions.

Rendering using CineRender R15

Version 2016 includes the render engine from CINEMA 4D R15 by Maxon: CineRender R15.

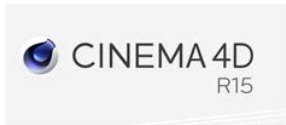

In particular, this render engine makes it possible to render images using ambient occlusion (see "New shading technique: ambient occlusion (on page 59)").

To find out more about CineRender R15, visit Maxon's website (<http://www.maxon.net/de>).

New shading technique: ambient occlusion

The integrated CineRender R15 render engine allows you to use another shading technique: ambient occlusion.

Ambient occlusion is a shading technique you can use together with the rendering method of global illumination. Ambient occlusion produces realistic shadows in a relatively short period of time. Another advantage of this technique is that it emphasizes details by applying shadows to edges and corners.

For example, you can use ambient occlusion to simulate lighting conditions when the sky is cloudy and there is no direct sunlight. You can use this technique both for interior scenes and exterior scenes.

It goes without saying that you cannot produce physically correct results within a short period of computing time. However, the result is usually so good that you do not need to render the scene using one of the compute-intensive rendering methods.

Note: If you want to produce physically correct results, there is no

way around the compute-intensive rendering methods illuminating the scene globally and correctly.

The following illustrations show the effects of ambient occlusion. The image on the left does not use ambient occlusion, whereas the image on the right uses this technique.

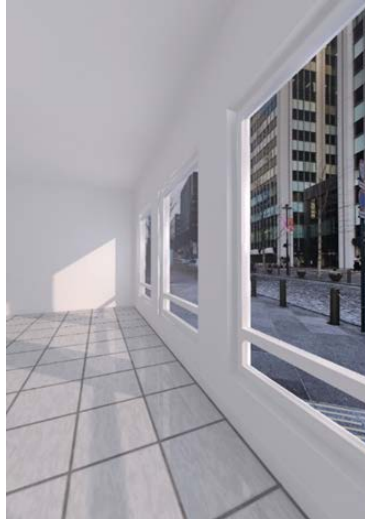

To render an image using ambient occlusion

- 1 Click  **Render (How)**.

The **Render** palette opens.

- 2 In the **General settings** area, select the **Ambient occlusion** option.

Note: This setting also applies when you record a movie using the **Render** calculation method.

- 3 If you want, you can define more parameters for ambient occlusion.

To do this, go to the **Quality** area and click the **Edit** button to the right of **Advanced settings**.

- 4 Render the image.
-

SmartParts

The proven SmartPart tools with a multitude of parametric objects play an important role when it comes to customizing layouts and displaying them in a practice-oriented manner. We are continuously adding new SmartParts to our collection to fulfill the growing demands on these objects, thus making layout creation even more efficient.

Allplan 2016 introduces new object models: lifting door and skylight.

- The lifting door was specially designed for industrial construction.
- The skylights complete the range of windows and doors.

Preview icons for your own SmartParts

When you stored SmartParts in the library, Allplan automatically assigned the same preview icons to SmartParts of the same type. Although you could change these icons, this involved considerable time and effort.

For example, these were the preview icons for new window SmartParts:

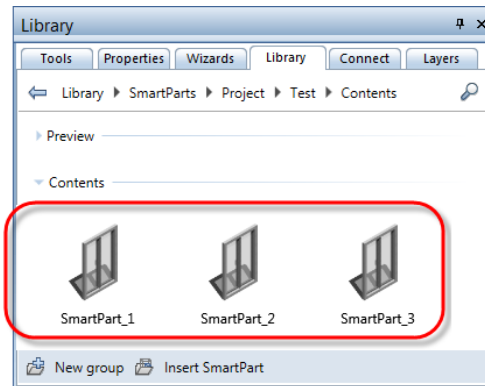

Allplan now provides a new service: as soon as you save a new SmartPart to the library, Allplan will generate a preview icon that is based on the actual SmartPart.

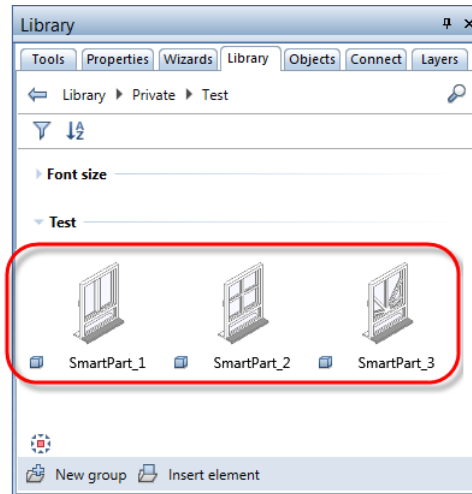

Consequently, each SmartPart gets its own preview icon. So it is easy for you to tell the SmartParts apart.

Skylight SmartPart

You can find a new tool in the **General: Roofs, Planes, Sections** module (Create area):  **Skylight SmartPart**. Using this tool, you can create SmartParts for rectangular skylights.

After you have selected this new tool, the **Properties** palette of the **Skylight SmartPart** opens on the **Elements** tab and you can immediately start modeling your own SmartPart. Using the **Shading** tab, you can assign roller shutters or sunblinds to the skylight.

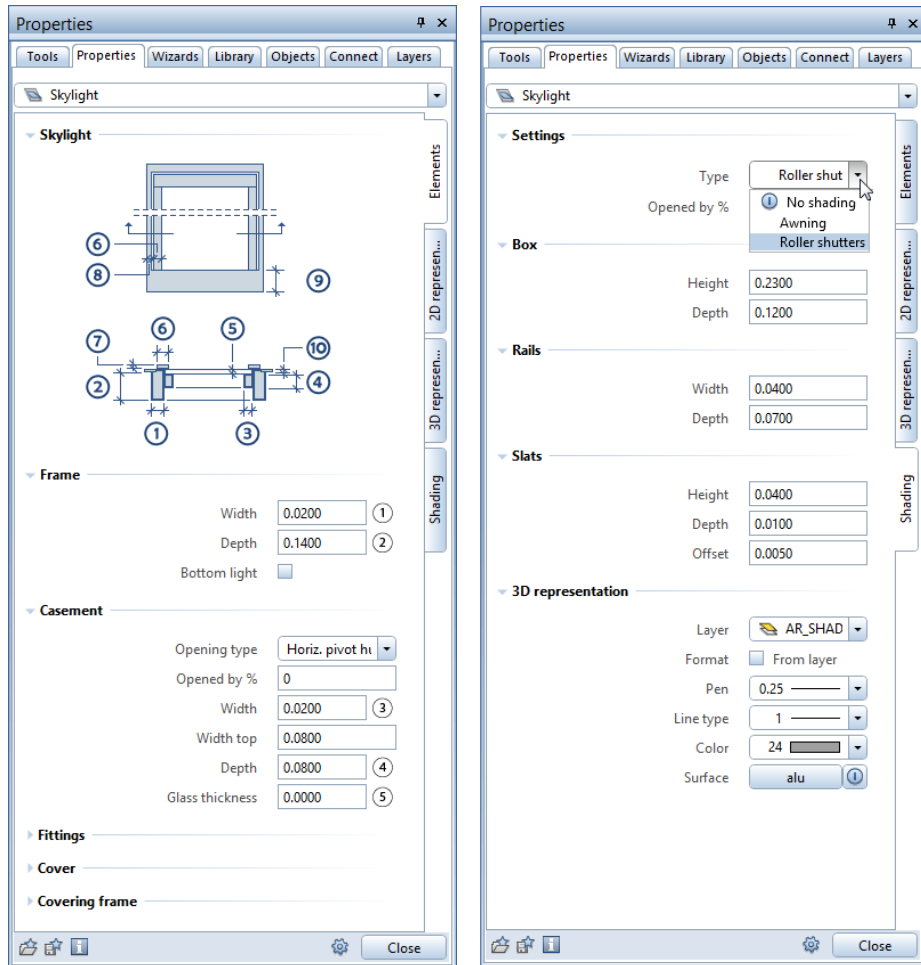



You can insert **Skylight SmartParts** in rectangular roof openings. Like any other SmartPart, **Skylight SmartParts** can be modified graphically using handles. Of course, you can also change the parameters using the palette.

You can save your SmartParts as favorite files using  **Save as a favorite**. You can also add them to the library.



You want to analyze **Skylight SmartParts**? No problem! Open the  **Reports** tool and select the `Skylights.rdlc` file. This report lists the skylights (by opening type) and dimensions of the unfinished openings (width, length, area).

New fittings for window SmartParts and door SmartParts

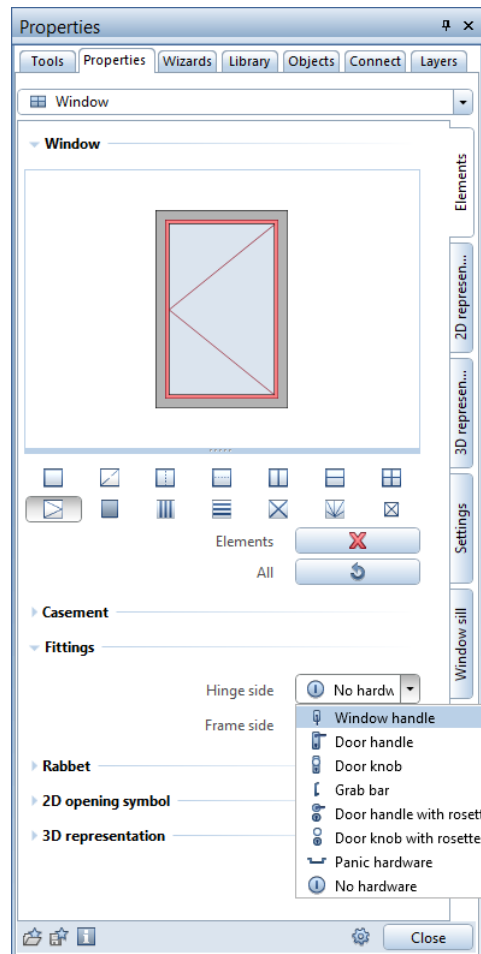
When modeling SmartParts using the  Window SmartPart and  Door SmartPart tools (Basic: Walls, Openings, Components module - Create area), you can choose from a wide range of new fittings:



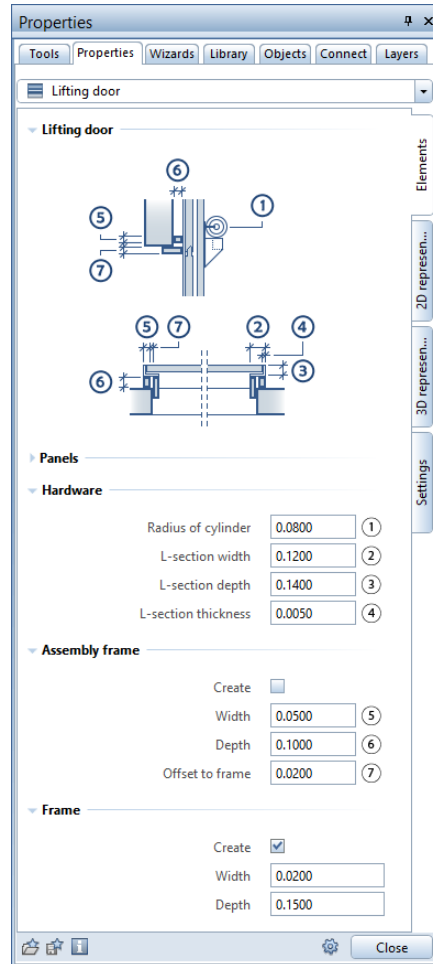

New door SmartPart

You can find a new SmartPart in the  Door SmartPart tool (Basic: Walls, Openings, Components module - Create area):  Lifting door.



You want to analyze SmartParts for lifting doors? No problem! Open the  Reports tool and select the file you need, for example, Doors (detailed).rdlc.

Surface elements in 2D and 3D

When modeling SmartParts using the  Window SmartPart and  Door SmartPart tools (Basic: Walls, Openings, Components module - Create area), you can select surface elements for displaying the SmartParts in 2D and 3D. You can assign a Hatching style, a Pattern, a Fill or a Style area to the surfaces.

Here is an example of a window SmartPart with integrated roller shutters and window sills:

Settings for the Surface elements on the 2D representation and 3D representation tabs in the palette of the window SmartPart:

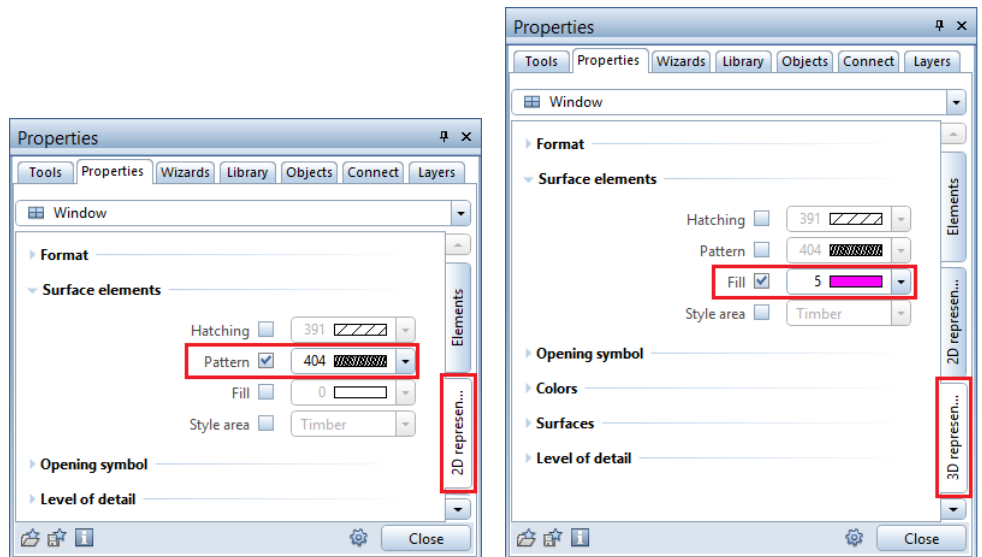

Settings for the surface elements of the integrated window sills and roller shutters:

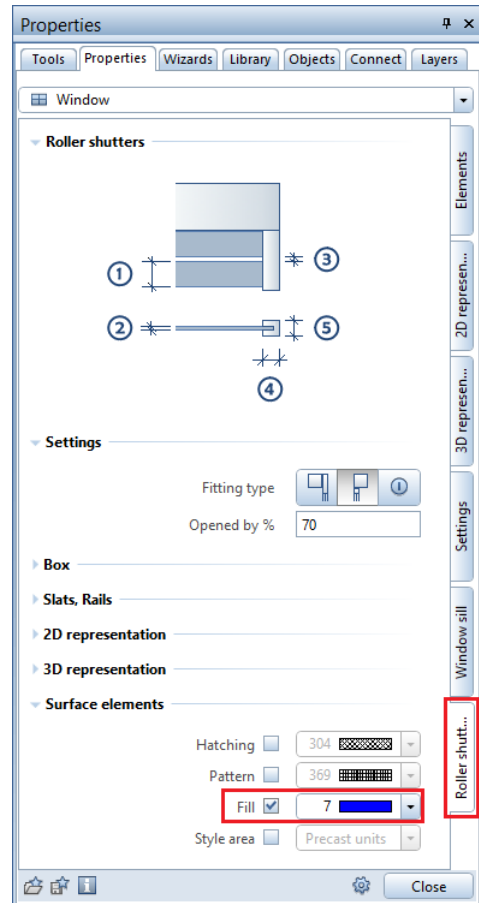
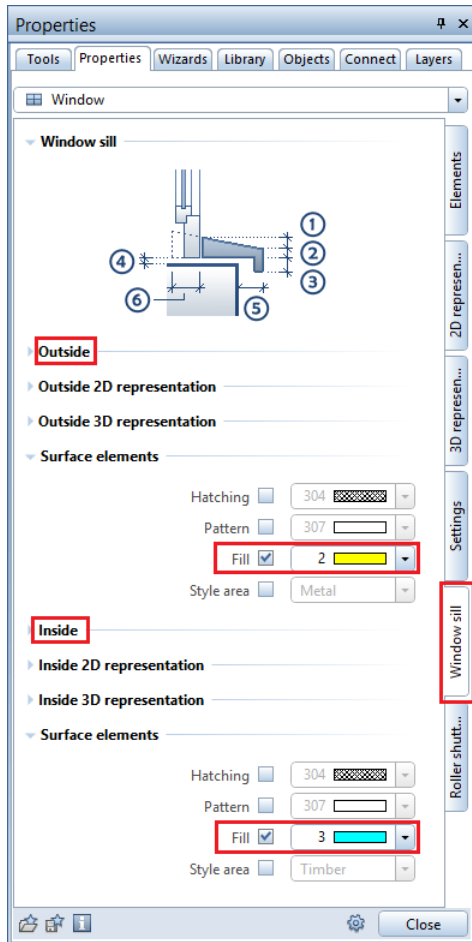

The result looks like this:

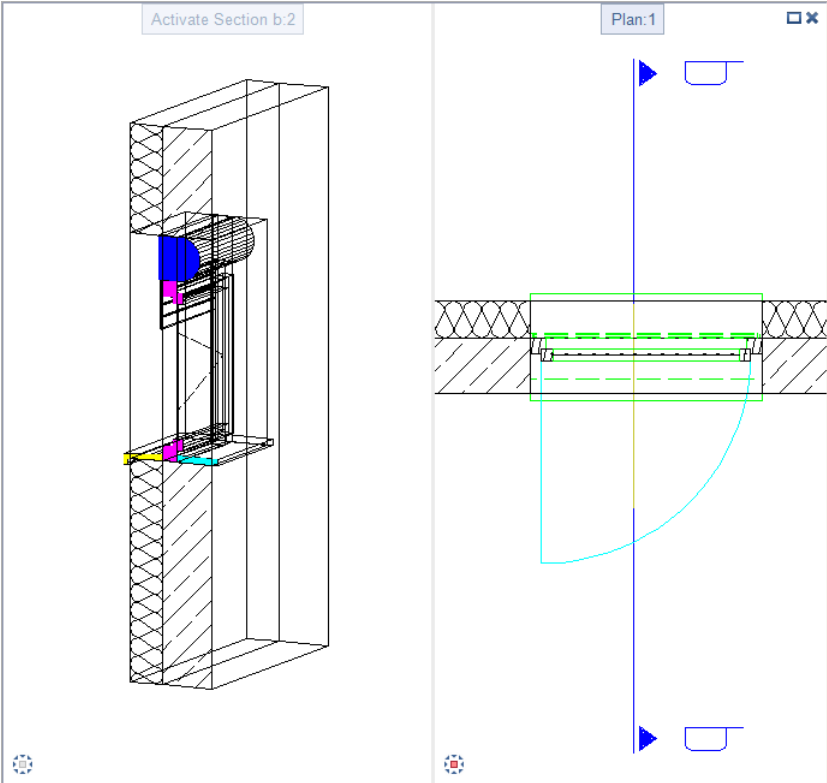

More new features in the Architecture family

Door swing as an architectural element

If you wanted to change the pen, line, color or layer of a door swing in earlier versions, you could not do so until you placed the door swing symbol again.

Allplan 2016 treats door swings as discrete architectural elements.

When you click the line or arc, Allplan selects the element in its entirety. You can then edit it in a single step using  **Modify Format Properties**, for example. You must use SmartParts if you want to assign different format properties or layers to the arc and the line.

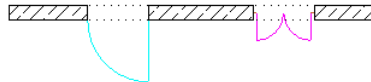

Note: When you use a smart symbol for the door swing, Allplan 2016 - like the previous version - does not modify the invisible components of the smart symbol.

Libraries

The library in **Allplan** offers architects a wide range of useful objects. You can find a number of new objects in the library of **Allplan 2016**, such as new trees, hedges, skylights and doors. In addition, we revised various objects, making the library even easier to use. Moreover, we added new tools to the library. For example, you can now select multiple entries and filter and sort the entries in the library. These new features make your work even more efficient and flexible.





General new features for libraries

Flat hierarchy

In earlier versions, Symbols, Smart symbols and SmartParts were in separate folders. After you had opened the library palette, you first had to choose the type. Then you could select the element. Similarly, you first had to choose the type before you could look for an element, that is to say, searching was restricted to the selected type.

Now there is only one level in the hierarchy. Regardless of its type, each library element can be in any folder. Now you can search across all element types. Allplan will scan all library elements in the folder where you start searching and in all subordinate folders.

You can easily tell the elements apart. Just look at the small symbol indicating the type of library element:

-  Symbol or  Symbol with resources
-  Smart symbol or  Smart symbol with resources
-  SmartPart

Basic rules



The following rules apply to the library palette:

- A symbol name can be up to 70 characters long.
- A path name can be up to 180 characters long.
- You cannot use the following special characters:
- / \ : " ? * > < |
- You can create as many subfolders as you need. Remember: the path name must not exceed 180 characters.

Sorting and filtering

Using  **Filter**, you can show or hide specific types of library elements (symbols, smart symbols, SmartParts).

Using  **Sort criterion**, you can sort the library elements alphabetically or by date in ascending or descending order.

Using  **Hide empty folders**, you can hide folders without library elements. When selected, the icon changes to  and it is pressed in.

Single files instead of catalog folders

Symbols and smart symbols used to be stored in catalog folders (ZSY or OM*). Those catalog folders were closed containers. You had to use special tools for administration. Although it was possible to create single files (*.SYM or *.NMK), they were an exception, not the rule.

Allplan now saves all library elements as separate files to the **\Library folder**:

- Symbols as *.SYM files
- Smart symbols as *.NMK files
- SmartParts as *.SMT files as usual

Managing library elements

You no longer manage library elements in **ProjectPilot**. Therefore, we removed the corresponding tools.

Similarly, the path settings for symbol files and smart symbol files ( **Options - desktop environment - Save to**) are no longer necessary. Therefore, we removed those settings, too.

Managing library elements in the library palette

You use the toolbar at the bottom of the library palette to create new folders and groups and to insert library elements.

To access more administration tools, click  or open the shortcut menu. Depending on the selected path, you can copy, rename, cut or delete folders and library elements.

In addition, you can open folders (*except* the folders in the **Default** path) straight in Windows Explorer.

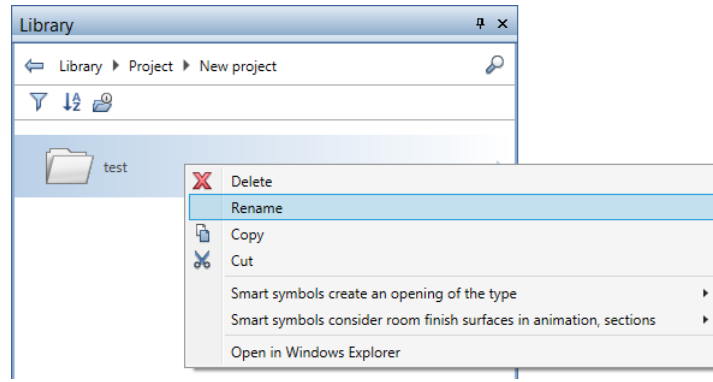

Managing library elements in Windows Explorer

Particularly if you want to copy, move or rename large amounts of data in the **Library** palette, it is a good idea to use Windows Explorer with its extensive options instead of modifying each individual folder or library element using  or the shortcut menu.

To manage library elements in Windows Explorer

- 1 Open the **Library** palette.
- 2 Select the path (you cannot select the **Default** path).
- 3 Go to the folder you want to change.
- 4 Click this folder with the right mouse button. On the shortcut menu, select **Open in Windows Explorer**.

The folder opens in **Windows Explorer**.

- 5 Edit the folder in **Windows Explorer**.
- 6 Close **Windows Explorer**.

The library palette updates immediately to reflect the changes. If this is not so, just open the superordinate folder.

Symbols and smart symbols with resources





You can find the **Resources included** option when you click  or open the shortcut menu of modifiable symbols and smart symbols (in the **Office**, **Project**, **Private** and **External** paths).

You can use this option to define whether Allplan is to save the resources together with the library element or take them from the current project.

- If the **Resources included** option is not active, Allplan will use the resources from the corresponding project.
- If the **Resources included** option is active, Allplan will apply the current resources to the library element, saving them with the library element. As a result, the library element will always look the same even if you use it in other projects. This enables you to give your own library elements with resources to partner offices.

You can even select several elements and include the resources in a single step.

Special symbols indicate library elements with resources.

-  Symbol or  Symbol with resources
-  Smart symbol or  Smart symbol with resources

Libraries provided

We adjusted and restructured the libraries that come with Allplan. The symbols are now stored in the ETC folder, which contains all data provided. Consequently, you can no longer find the SYM folder in the STD folder (office standard).

New library elements

The libraries that come with Allplan include a wide range of new library elements:

- Mediterranean tress
Five tree species in three sizes each
- Hedges
In three sizes
- Skylights
Various pivot windows and top hung windows are available as SmartParts.

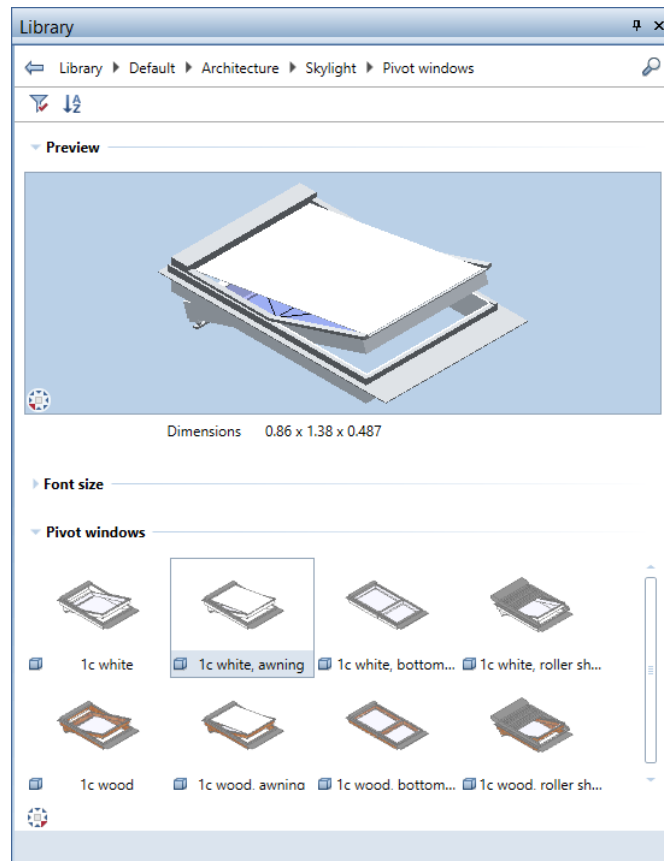

Revised library elements

We revised and restructured the library elements.

- We removed a number of library elements, speeding up installation. You can still find these library elements in Allplan Connect.
- We restructured the library elements, making your workflows more efficient.
- You can find the complete libraries of the previous version in Allplan Connect.
- We revised and simplified the resources and definition of smart symbols.

Definition and resources of smart symbols

We revised the definition and resources of smart symbols, making it easier for you to change their appearance. You can now adjust the line color quickly and easily. The same applies to fills in 2D and resources in 3D.

This results in simple, attractive Allplan content that can also be used internationally.

We changed the following:

- Smart symbols are easier to use. They have one foil for 2D and 3D each. Therefore, they no longer depend on the reference scale.
- The **Default** layer and the **Placement** format are used to display smart symbols in 2D.

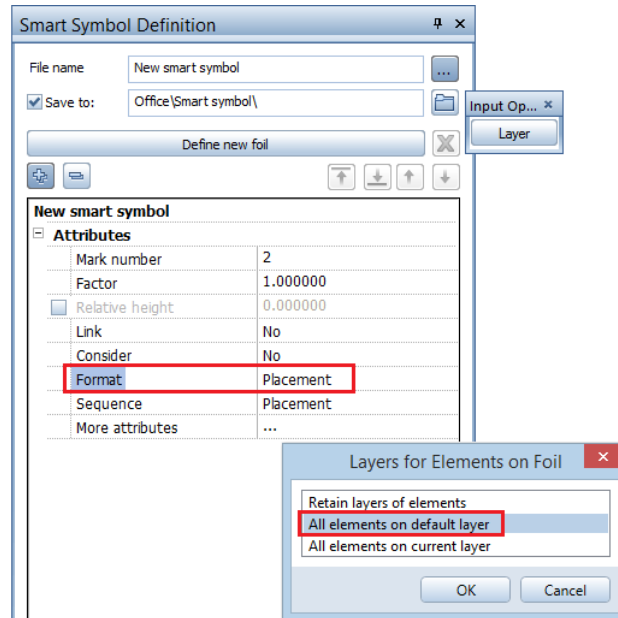

- There is only a single style area for each 2D representation, allowing you to work flexibly and to use drawing types.
- When you install Allplan for the first time, you will get new style areas for smart symbols.
- When you upgrade, Setup will not install the new style areas automatically, thus making sure your office standard will not be overwritten. You can add the new style areas later.

Data conversion of your own libraries when upgrading

When you upgrade an earlier Allplan version to Allplan 2016, the program will automatically convert the symbol catalogs and smart symbol catalogs you defined yourself, making sure the changes to the catalog files (ZSY and OM*) are consistent and not restricted to the libraries provided.

All symbols in the ZSY catalog files become separate symbol files (name.SYM); each file gets the name of the original symbol. The same applies to smart symbols in the OM* catalog files: they become separate smart symbol files (name.NMK); each file gets the name of the original smart symbol.

SmartParts have always been saved as separate files. When you upgrade, only the folders will be moved.

Note: The original symbol catalogs and smart symbol catalogs are not lost. During the upgrade, the program separates them into single files. Then it copies and writes them as a backup file to the TMP\Library\bak folder. Date and time are included in the file name.

The manner in which library elements are distributed to folders depends on the path. Distribution in the Office path differs from that in the Project and Private paths.

Libraries in the office standard

The catalogs in the office standard are used by all employees in an office. These catalogs usually contain a large number of elements and have a clear structure. So that you immediately find your way around the flat hierarchy in the **Library** palette, the structure is almost the same.

The smart symbol folders have the same name. You can find SmartParts and symbols in the `_SMARTPARTS` and `_SYMBOLS` folders, respectively.

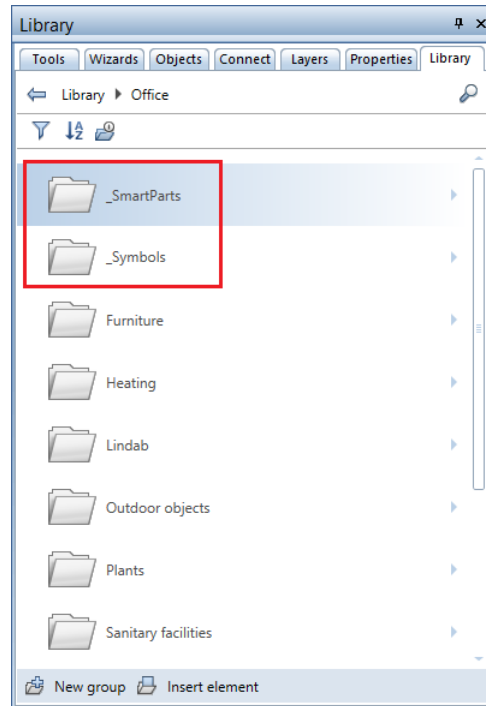

Libraries in the project and private paths

Catalogs in the **Project** and **Private** paths usually contain fewer elements than those in the office standard. The data in these paths are usually customized for specific projects.

When converting data, Allplan thus merges contents of catalog files with the same name, regardless of the type of the library element. For example, if there is one window folder for smart symbols and SmartParts each, Allplan will combine the smart symbols and SmartParts from these two folders in a single new folder called windows.

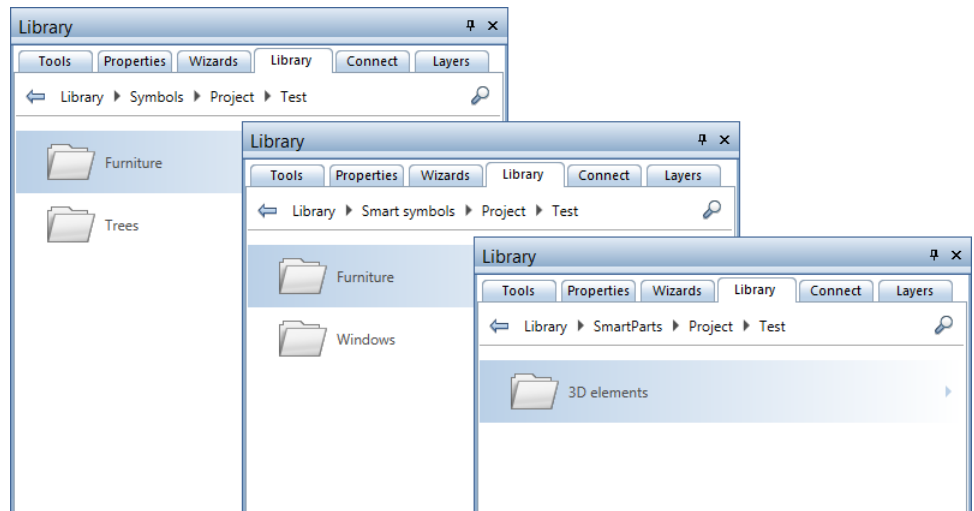

Initial situation: Symbols, smart symbols and SmartParts in the earlier version

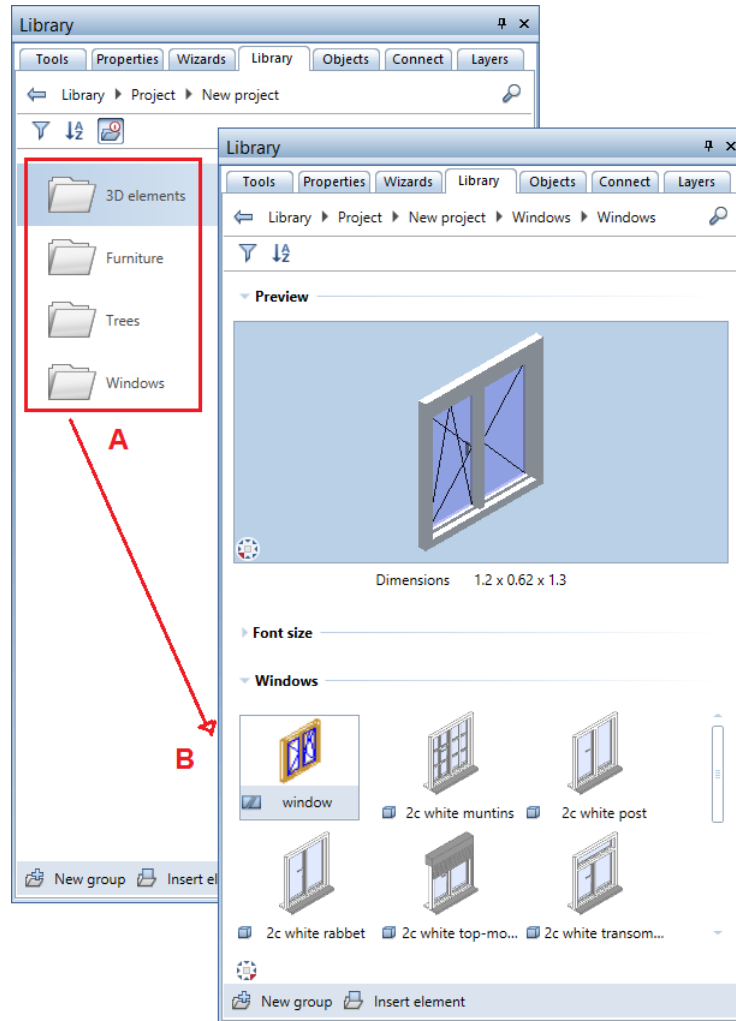

After the upgrade:

- A All library folders of the project are in the same place
- B Smart symbols and SmartParts are in the same folder

External path

Paths you defined for the External path folder in earlier versions stay the same. In Allplan 2016 you can save any library element in these paths, regardless of its type.

Libraries from Allplan 2015

We adjusted and restructured the libraries that come with **Allplan 2016**. If you want to use symbols, smart symbols or SmartParts from the libraries of **Allplan 2015**, you can download those library elements as ZIP files with German or English names from **Allplan Connect**.

To import the data, you can use the **External path** folder in the **Library** palette. Allplan automatically converts the data during import. You can then move the data from the **External path** folder to a different folder, such as the **Office**, **Private** or **Project** folder.

Note: Data conversion can take some time, in particular, when Allplan converts all symbol folders. If you know which folders you want to use in Allplan 2016, you should select these data in **Windows Explorer** and move them to a separate folder.

You can find more information in the help for Allplan. See the section "Using libraries of earlier versions".

Section Along Curve

Unlike associative views and sections, the model data of sections along curves do not have permanent references. Depending on the setting, the section takes the information it needs from the model without interrupting the workflow of other users, for example, in a workgroup environment. So you can move the section without loading the model.

What to display and how

The **Section Along Curve** palette offers the additional **Filter** area, where you can select the elements you want to display in the section. In addition, you can define whether the section is to update automatically to reflect any changes you make in the palette or in the 3D model.

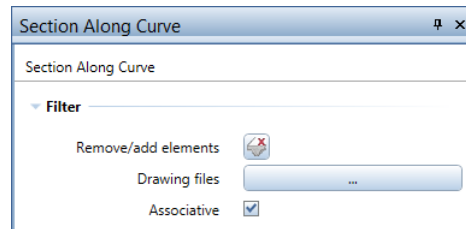

Remove/add elements

After having clicked the  **Remove/add elements** icon, you can select the elements you do not want to display in the section. You can click any element in an open drawing file.

When you click the icon again, the elements you filtered out are displayed in the selection color. Click these elements if you want to add them to the section again. You can use the  **Brackets** to select several elements in one go.

Drawing files



You can select the drawing files you want to use for the section. Click the button to open the **Select drawing file** dialog box, which displays all open drawing files. When modifying sections, you can see all drawing files you used for the section, regardless of whether they are open or not.

Associative

By selecting this option, you create an associative section. Consequently, the section updates immediately to reflect any changes you make in the palette. This also applies to changes in the 3D model. Here, too, the section updates automatically without you having to select the modification tool. When you create new elements, however, the section will not update until you modify it.

Sections that are not associative get a double view border.

Dimensions

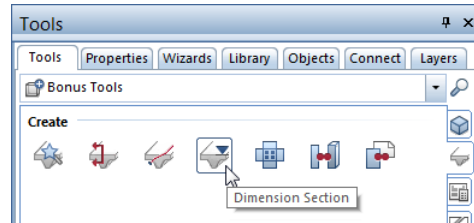

To dimension sections along curves later, you can use the new  **Dimension Section** tool ( Bridge and Civil Engineering module - Create area).



After you have clicked the view border of a section, the steps are similar to those in  **Elevation Point**. There are the following differences:

- Clicking the first point to be dimensioned defines the position of the dimension line.
If the **Symbol at reference point** option is not active, the first point defines the position for all the other elevation points. You can move the elevation dimensions later using the  **Move Dimension Line** tool in the **Dimension Lines** module.
- Allplan takes the reference point for elevation dimensioning from the section.

Notes:



- While creating elevation dimensions, you can change the global dimension line parameters at any time. The context toolbar provides several options.
- Double-click a dimension line with the left mouse button to open the **Dimension Line** dialog box, where you can modify the parameters. In this case, the dialog box also includes the **Section/Point** tab.
- To modify the elevation dimensions of the section, you can use a lot of tools of the **Dimension Lines** module. You can select these tools on the shortcut menu of the dimension line. For example, you can use  **Add Dim. Line Point** or  **Del Dim. Line Point**.

Engineering

In addition to the new features and improvements mentioned below, development for engineering focused on entering lengths in feet and inches. When you install the US country package, you immediately get the defaults used in the USA.

Modifications using handles

Allplan 2016 offers more options for modifying linear placements using handles. You can now change the diameter by selecting an entry in the list box.

If there are  **Point handles**, you can also change the dimension that is perpendicular to the placing line. This allows you to change the bending shape without selecting the  **Stretch Entities** tool.

Another new feature is the option to modify only a part of the placement. This creates a new placement. When you change the diameter or the bending shape, the modified placement will be given a new mark number.

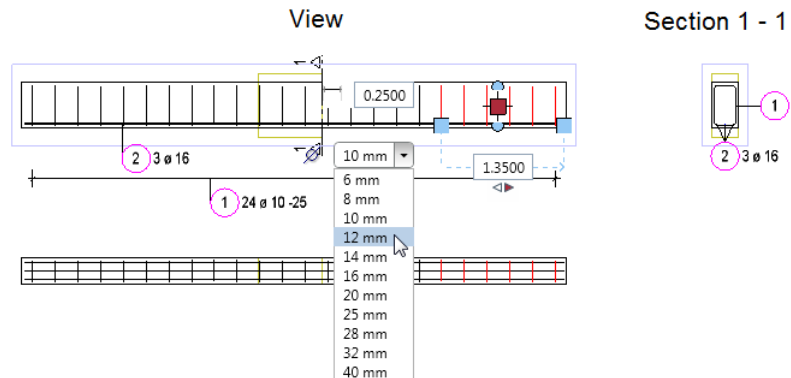



Exporting bar reinforcement

Using the  **Options - Import and export** page, you can now define how Allplan is to export reinforcing bars.

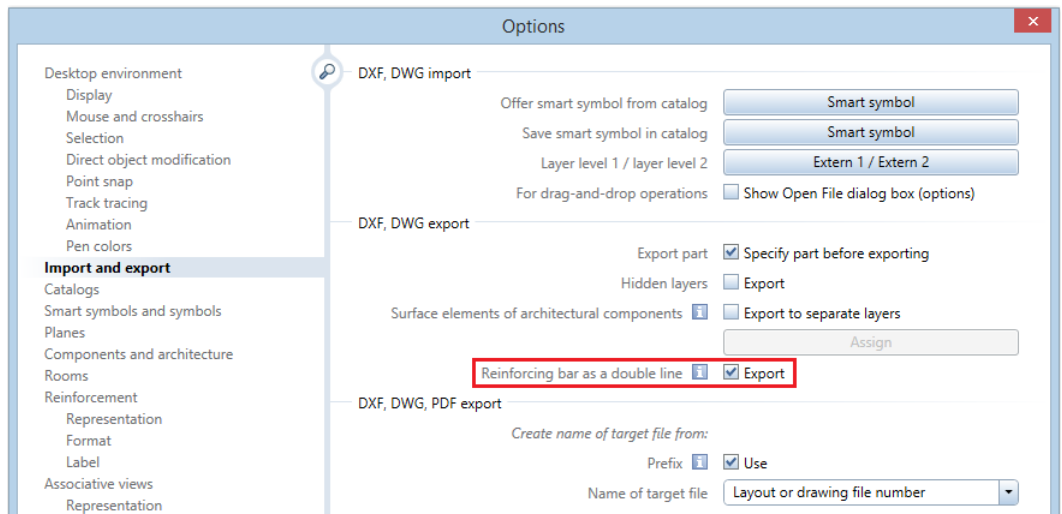
When you select **Export reinforcing bar as a double line**, Allplan will export the reinforcing bars using their actual extents. Otherwise, only the center lines of the bars will be exported. Intersected bars displayed as points will always be exported using their real extents.



Symbol selection

When you need a symbol for a  cross-section in the  **Bridge**, **Civil Engineering Component** tool or for a  shaped fixture, you can now select this symbol in the **Library** palette. The filters are preset so that you can see only folders with 2D symbols. To select a symbol in any folder, open the **External path** folder and set the external path to the folder you need.

Additional steel grades for Australia

The revised cross-section catalogs for Australia provide the additional AS R250N bar cross-section catalog. The bar cross-section catalog AS 500N was renamed AS D500N. When you upgrade, Allplan copies the new cross-section catalogs to the ...Programs\Allplan\Allplan 2016\New\Ing folder, preventing data from being overwritten.

To use the new cross-section catalogs, open the overview of cross-section catalogs (Tools menu --> Defaults --> Cross-section catalogs) and import the aausqusr.txt file (in the ...Programs\Allplan\Allplan 2016\New\Ing folder) as a  Favorite. If you work with project-specific bar and mesh cross-section catalogs and the new cross-section catalogs are in the office standard, you can switch the path setting for cross-section catalogs to Office and then back to Project.

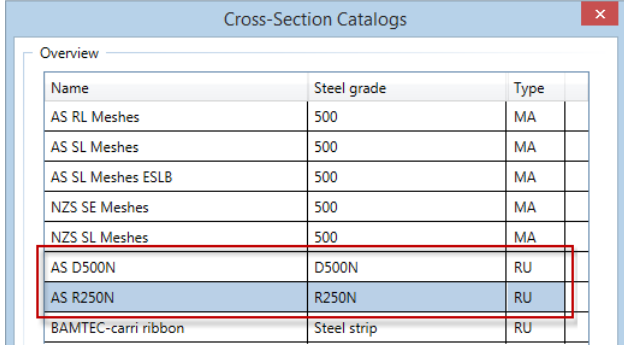

The screenshot shows the 'Cross-Section Catalogs' dialog box with the 'Overview' tab selected. It contains a table with three columns: Name, Steel grade, and Type. The table lists several catalog entries, with 'AS D500N' and 'AS R250N' highlighted in blue and enclosed in a red rectangular box.

Name	Steel grade	Type
AS RL Meshes	500	MA
AS SL Meshes	500	MA
AS SL Meshes ESLB	500	MA
NZS SE Meshes	500	MA
NZS SL Meshes	500	MA
AS D500N	D500N	RU
AS R250N	R250N	RU
BAMTEC-carri ribbon	Steel strip	RU

Associative Views

We optimized various features for associative views and sections, making them even easier to use. Allplan 2016 is the first version to support direct object modification for associative views and sections: you can now use handles to modify the section object.

Unwanted linking of drawing files

Think of the following situation: you work with references and you create the associative views and sections and the reinforcement model in one and the same drawing file. As soon as you load the 3D model, Allplan will automatically load the reinforcement model in the background. This will considerably slow down your computer, in particular with complex layouts.

To avoid this unwanted linking of drawing files, Allplan will now issue a corresponding message when you create views and sections in a drawing file with reinforcement or when you create reinforcement in a drawing file with views and sections.

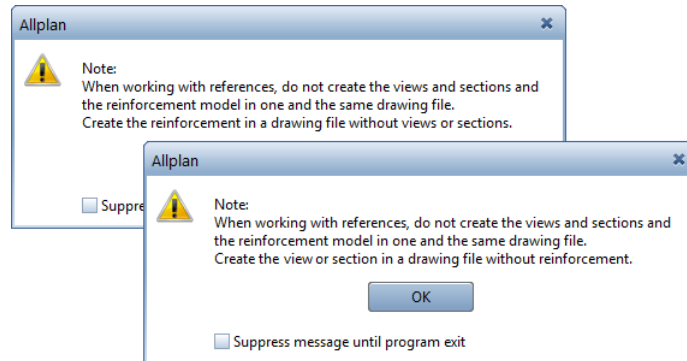

Modifying text parameters

When you  **Modify View and Section Properties**, you can now change the text parameters of labels. You can immediately see the effects of your changes on screen.

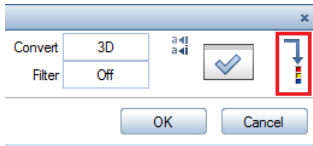

Section display

The **Section Display** list box on the viewport toolbar lists associative sections placed with a clipping line in addition to architectural sections created with  **Clipping Path**.

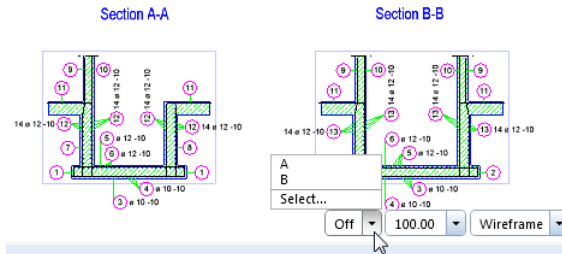

To display model data within the section object, you have the following options:

- Open the **Section Display** list box on the viewport toolbar and click the section identifier.
- Open the **Section Display** list box on the viewport toolbar, click **Select** and then the section identifier.

To switch section display off again, open the **Section Display** list box on the viewport toolbar and click  **Off**.

Index

3

- 3D circle - 35
- 3D modeling - 33
- 3D spline - 35

A

- ambient occlusion - 59
- associative views - 95
 - modify text parameters - 97
 - section display - 98
 - unwanted linking of drawing files - 96
- AutoCAD - 51

C

- chamfer edge - 47
- CINEMA 4D - 51
- convert elements - 50
- copy light sources - 57
- cylinder - 36

D

- data exchange - 51
 - AutoCAD - 51
 - CINEMA 4D - 51
 - DGN interface - 28
 - DXF/DWG import - 27
 - IFC interface - 29
 - import LandXML data - 30
 - Rhino - 51
- data transfer to SCIA - 30
- DGN interface - 28
- dock and float viewports - 11
- DXF/DWG import - 27

E

- element filter - 49
- engineering - 91
 - additional steel grades for Australia - 94
 - export bar reinforcement - 93
 - handles for modifications - 92
 - symbol selection - 93

- entries in feet and inches - 21
- extrude - 43
- extrude along path - 38

F

- fillet edge - 46
- fittings (window SmartParts and door SmartParts) - 67

G

- Grafikfenster - 11
 - dock, to Allplan application window - 13
 - float freely - 12
 - place, in front of or behind Allplan application window - 12

I

- IFC interface - 29
- illuminance - 58
- import LandXML data - 30
- intensity of light - 58
- interfaces - 51
 - AutoCAD - 51
 - CINEMA 4D - 51
 - DGN interface - 28
 - DXF/DWG import - 27
 - IFC interface - 29
 - import LandXML data - 30
 - Rhino - 51

L

- layouts and printing - 31
 - resizing factor for multiple output - 31
 - rotate print preview - 32
 - transfer layer visibility - 32
- libraries - 73
 - basic rules - 74
 - data conversion - 81
 - data structure - 75
 - default (provided) - 77

- filter - 75
- from earlier versions - 85
- hierarchy - 74
- manage - 75
- resources (symbols, smart symbols) - 77
- sort - 75
- license server - 10
- licensing - 3
- lifting door (SmartPart) - 68
- loft - 40

M

- modeling kernel - 34
- modify 3D - 44
 - chamfer edge - 47
 - element filter - 49
 - fillet edge - 46
 - handles - 44
 - modify edge offset - 46
 - modify, as in 2D - 48
 - properties palette - 44
- modify edge offset - 46
- modify, as in 2D - 48
- multi-display support - 11

O

- object navigator - 14
- objects palette - 14

P

- Parasolid - 34
- presentation
 - ambient occlusion - 59
 - CINEMA 4D - 51
 - copy light sources - 57
 - illuminance - 58
 - intensity of light - 58
 - white model - 53
- preview icons (SmartParts) - 64

R

- render
 - ambient occlusion, shading technique - 59
 - CineRender R15 - 59
 - more information, real-time rendering - 55
- Rhino - 51

- rotate - 39
- round 3D elements - 35

S

- section along curve - 87
 - dimensions - 90
 - what to display - 88
- simplified model - 56
- skylight (SmartPart) - 65
- SmartParts - 63
 - fittings for windows and doors - 67
 - lifting door - 68
 - preview icons for your own SmartParts - 64
 - skylight - 65
 - surface elements in 2D and 3D - 69
- sphere - 37
- sweep path - 42

V

- view types
 - more information, real-time rendering - 55
 - simplified model - 56
 - sketch, optimized - 54
 - white model - 53

W

- white model - 53